

RESTRICTED

NATIONAL ADVISORY COMMITTEE  
FOR AERONAUTICS

JUN 2 1944

TECHNICAL NOTE

FOR REFERENCE

No. 935

NOT TO BE TAKEN FROM THIS ROOM

DYNAMICS OF THE INLET SYSTEM OF A FOUR-STROKE ENGINE

By R. H. Boden and Harry Schecter  
Massachusetts Institute of Technology



Washington  
May 1944

NACA LIBRARY  
LANGLEY MEMORIAL AERONAUTICAL  
LABORATORY  
Langley Field, Va.

CLASSIFIED DOCUMENT

This document contains classified information affecting the National Defense of the United States within the meaning of the Espionage Act, USC 50:31 and 32. Its transmission or the revelation of its contents in any manner to an unauthorized person is prohibited by law. Information so classified

may be imparted only to persons in the military and naval Services of the United States, appropriate civilian officers and employees of the Federal Government who have a legitimate interest therein, and to United States citizens of known loyalty and discretion who of necessity must be informed thereof.

RESTRICTED

RESTRICTED

NATIONAL ADVISORY COMMITTEE FOR AERONAUTICS

TECHNICAL NOTE NO. 935

DYNAMICS OF THE INLET SYSTEM OF A FOUR-STROKE ENGINE

By R. H. Boden and Harry Schecter

SUMMARY

Tests were run on a single-cylinder and a multicylinder four-stroke engine in order to determine the effect of the dynamics of the inlet system upon indicated mean effective pressure.

Tests on the single-cylinder engine were made at various speeds, inlet valve timings, and inlet pipe lengths. These tests indicated that the indicated mean effective pressure could be raised considerably at any one speed by the use of a suitably long inlet pipe. Tests at other speeds with this length of pipe showed higher indicated mean effective pressure than with a very short pipe, although not so high as could be obtained with the pipe length adjusted for each speed. A general relation was discovered between optimum time of inlet valve closing and pipe length; namely, that longer pipes require later inlet valve closing in order to be fully effective.

Tests were also made on three cylinders connected to a single pipe. With this arrangement, increased volumetric efficiency at low speed was obtainable by using a long pipe, but only with a sacrifice of volumetric efficiency at high speed. Volumetric efficiency at high speed was progressively lower as the pipe length was increased.

INTRODUCTION

It has long been recognized that the volumetric efficiency and hence the mean effective pressure of an internal combustion engine is affected by the dynamics of

RESTRICTED

the inlet system. (See references 1 to 19.) The present work was undertaken in order to make a more systematic and extensive investigation than had been made before, and to attempt to devise a mathematical analysis which would lead to a better understanding of the observed phenomena.

The work was done under the auspices of the National Advisory Committee for Aeronautics. The experimental work was done in the Sloan Automotive Laboratory at the Massachusetts Institute of Technology under the supervision of Professor E. S. Taylor. A theoretical analysis of this problem may be found in Item 4 of the Bibliography.

## APPARATUS AND METHOD

### Single-Cylinder Engine

The first part of the experimental work was done on an NACA universal test engine (bore 5 in., stroke 7 in.) equipped for variable valve timing (reference 20). Variables were controlled as follows:

Fuel . . . . .	87-octane aviation gasoline
Compression ratio (all runs) . . . . .	5.0
Cooling water temperature (all runs) . . . . .	175° to 185° F
Fuel-air ratio (each run) . . . . .	set for best power
Spark timing (each speed) . . . . .	set for best power
Speed . . . . .	variable, 1000 to 1600 rpm
Inlet pipe length, variable, by increments 9 to 247 inches	
Inlet pipe diameter . . . . .	2.56 or 1.88 inches
Inlet valve lift . . . . .	0.312 inch
Exhaust valve lift . . . . .	0.275 inch
Exhaust opening (25° B.B.O.) . . . . .	155°
Exhaust closing (25° A.T.C.) . . . . .	25°

(Crank angles are measured from top dead center unless otherwise indicated.)

In order that the air flow should not be disturbed by the restriction of a carburetor venturi, fuel was injected directly into the cylinder for all tests.

Photographs of the general setup are given in figure 1, and a diagrammatic sketch in figure 2. (Further experimental details will be found in reference 18.)

One series of runs was made with a constant "standard" inlet valve timing as follows:

Inlet opening (25° B.T.C.) . . . . .	335°
Inlet closing (25° A.B.C.) . . . . .	205°

A further series was made at constant speed (1600 rpm) and variable inlet timing as follows:

Inlet opening (45° to 15° B.T.C.) . . . . .	315° to 345°
Inlet closing (15° to 45° A.B.C.) . . . . .	195° to 225°

Measurements of torque were made for each run. Friction was estimated by the usual method, "motoring" at several speeds. From the torque resulting from the addition of the measured torque to the motoring torque for the same speed, the indicated mean effective pressure (imep) was computed and plotted in figures 3 to 5.

In addition to the foregoing measurements, records were taken of the pressure at the valve end of the inlet pipe for all tests. In later tests where the valve timing was varied, records also were taken of pressure in the cylinder. These measurements were made by means of the M.I.T. indicator (reference 21). Sample diagrams are reproduced in figure 6.

Figure 7 shows a comparison of two curves of indicated mean effective pressure against pipe length, from two sets of data taken at an interval of about five months. Different cylinder heads of the same design were used. The data for the curve marked "Head 1" was taken in one continuous run; while each observation for the curve marked "Head 2" was taken on a different day.

## RESULTS

### Single-Cylinder Engine

Volumetric efficiency.- Volumetric efficiency may be defined by the expression

$$W = f V_d \rho_o E \quad (1)$$

where

- W mass of air taken in per unit time  
 f number of suction strokes per unit time  
 $V_d$  piston displacement of one cylinder  
 $\rho_0$  average inlet air density  
 E volumetric efficiency

Volumetric efficiency could be computed from a measurement of air quantity in addition to the ordinary measurements of speed, inlet pressure, and temperature; but in this work it was desirable to avoid the measurement of air, because the presence of meters or orifices would disturb the dynamics of the inlet system. On account of this difficulty, and since only relative values were required, it was decided to estimate the quantity of air from the

power measurement. The indicated horsepower =  $\frac{778 (W) (H) (\eta)}{550 \times 60 \times 60}$

where W is the mass of air consumed per hour, H is the heating value of unit mass of air, and  $\eta$  is the indicated thermal efficiency based on air; H and  $\eta$  are substantially constant since spark and fuel rate were adjusted for best power. Under these conditions M is proportional to indicated horsepower. From this relation it follows that volumetric efficiency is proportional to indicated mean pressure.

Effect of pipe length.— Varying the length of the inlet pipe at constant speed results in curves of indicated mean effective pressure against pipe length, as shown in figures 3, 4, and 5. Essential characteristics of these curves are:

1. A gradually rising mean effective pressure as pipe length is increased from as short as possible to a length which gives a frequency ratio\* of slightly more than 5

---

\*The "frequency ratio" here introduced is defined as the ratio of inlet pipe frequency to valve frequency (inlet pipe frequency being the fundamental frequency of the air column in the inlet pipe when the valve is closed and valve frequency being half the engine crankshaft frequency). Thus this frequency ratio is inversely proportional to the product of intake pipe length and engine speed.

2. At least three distinct peaks, at frequency ratios of slightly more than 5, 4, 3
3. A decrease in mean effective pressure for lengths longer than that giving a frequency ratio of 3

Figure 8 is a set of records of pressure in the pipe (near the inlet valve) and in the cylinder, at 1600 rpm. Pipe length is the single independent variable.

Essential characteristics of the pressure in the pipe are:

1. Gradually increasing amplitude of the pressure waves as pipe length is increased
2. Occurrence of a pressure peak near the time of inlet closing, arriving later as the length of pipe is increased

The cylinder pressure records of figure 8 show an interesting pressure minimum during the suction stroke, which moves to the right (i. e., comes later in the stroke) as pipe length is increased, until the number of pressure waves per engine cycle changes. When this occurs, the point of minimum pressure returns to approximately its original crank angle and again starts moving to the right as the pipe length is increased.

Figure 9 is a set of pressure records taken from the inlet pipe at 1220 rpm.

Effect of speed.- Figures 10 and 11 show the pressure in the pipe for various engine speeds. Similarity between these records and those of figures 8 and 9 is evident. When speed and pipe length are varied together so as to give a constant frequency ratio, the result is a set of very similar curves with amplitude increasing approximately in proportion to the speed. Figure 12 is such a set of curves. This suggests a plot of indicated mean effective pressure against frequency ratio for various values of speed as shown in figure 13. The first peak of indicated mean effective pressure, which occurs at a frequency ratio of approximately 3, decreases notably as speed increases; while the peak at 5 shows a much smaller variation, not consistently in either direction.

Effect of valve timing.- The effect of the time of

inlet-closing on indicated mean effective pressure is illustrated in figures 4 and 5 which show indicated mean effective pressure against pipe length for various valve timings. It will be noted that late inlet-closing improves the performance with long pipe lengths; while early closing is better for shorter pipe lengths. This is the result of later arrival of the pressure wave after bottom center which was noted in figure 8. Figure 14 is a series of records taken with inlet closing for best power in each case. Note that the closing of the inlet valve is slightly ahead of the pressure peak in all cases except with the shortest three pipes where the pressure peak is very close to bottom center. This is due to the effect of piston motion. If a series of compression curves is plotted, starting with various inlet pressures at bottom center and these curves are superimposed upon the pressure wave in the pipe, a point of tangency is obtained between one of the compression curves and the pressure in the inlet pipe. Provided the inertia of the air in the valve is negligible, this will be the point at which the valve must be closed in order to entrap a maximum quantity of air. Such compression curves have been drawn in figure 14. The actual valve closing is somewhat later than the points of tangency because the valve requires a finite time to close and is effectively closed somewhat earlier. The difference between actual closing and effective closing appears to be about  $10^\circ$  at 1600 rpm. This quantity would be expected to increase with speed. A direct comparison of the pressures in the cylinder and the pipe for different valve timings appears in figure 15. The curves marked "A" (fig. 15) indicate that a difference in timing may alter considerably the pressure in the pipe. In this case reverse flow induced by the piston motion apparently reinforces the pressure waves.

Effect of inlet pipe diameter. - Figure 16 is a plot of indicated mean effective pressure against inlet pipe length for a pipe approximately half the area of the pipe used in the other tests. The suppression of the peaks of the curve is notable in the case of the small diameter pipe.

Figure 17 shows the pressure waves in the small diameter pipe, for various lengths. On comparing these with figure 8, it is noted that the amplitude is greater in the case of the small pipe and that the pressure wave arrives later after bottom center, which indicates that a later timing might be expected to give higher indicated

mean effective pressure with the small pipe. Figure 18 is a direct comparison of the pressure in the pipe and the cylinder for a small and a large pipe of the same length. The points noted here are evident in this figure.

## APPARATUS AND METHOD

### Multicylinder Engine

Additional experimental work was carried out to determine the effect of having several cylinders connected to the same inlet pipe. The engine used for these tests was a six-cylinder Chrysler automobile engine. Engine data follows:

Serial No. . . . .	G121332
Bore . . . . .	3 $\frac{1}{8}$ inches
Stroke . . . . .	4 $\frac{3}{4}$ inches
Displacement (total) . . . . .	220 cubic inches
Valve timing:	
Exhaust opens . . . . .	40° B.B.C.
Exhaust closes . . . . .	4° A.T.C.
Inlet opens . . . . .	7° B.T.C.
Inlet closes . . . . .	55° A.B.C.

The cylinders of this engine were manifolded together in two groups of three within the cylinder-block casting as shown in figure 19. One group of three cylinders was separated from the other and was provided with separate inlet and exhaust connections. This group was used merely as an air pump, the remaining group of three cylinders being used to supply power to operate the air pump (fig. 20). Thus the three cylinders under investigation were motored without firing. They were arranged so that various lengths of inlet pipe could be attached to the inlet opening common to the three cylinders. The air exhausted by the three cylinders was led to a receiver, and the flow (volume per unit time) was measured by an NACA Roots type supercharger. This flow, corrected for temperature, was used to calculate the volumetric efficiency. (Correction for pressure was found unnecessary.) This method of test was justified by Mueller (reference 14), who showed that the curve of volumetric efficiency against pipe length, obtained by this method on a single-cylinder engine, was similar to the curve of indicated mean effective pressure against pipe length when the engine was firing. The



comparison of these curves taken from reference 14 is reproduced in figure 21. Indicator diagrams were made of the pressure in one of the three motoring cylinders, and in the inlet pipe, as near as possible to the engine.

## RESULTS

### Multicylinder Engine

Curves of volumetric efficiency against speed for various pipe lengths, and of volumetric efficiency against pipe length\* for various speeds are reproduced in figures 22 and 23. It is instructive to note that, while volumetric efficiency at low speed may be improved by the use of a long pipe, the improvement is at the expense of volumetric efficiency at high speed. Volumetric efficiency at high speed was not improved by additional inlet pipe length.

A study of the pipe pressure diagrams (fig. 24) reveals the interesting fact that all show the same frequency, the frequency of the suction strokes.

Figure 25 showing pressures in a 72-inch pipe for various speeds indicates phase shift as expected from theoretical considerations. The last diagram of this figure shows the higher modes of vibration of the air column in the pipe being excited, as would be expected.

## CONCLUSIONS

On the basis of the foregoing experimental investigation, the following conclusions may be drawn:

1. The pressure waves in the inlet pipe are of sufficient amplitude to affect the charging process (and hence the mep) considerably.

2. For a single-cylinder engine running at a given speed, there are three distinct optimum lengths of inlet pipe, with which the mean effective pressure is of the

---

\*"Pipe length" for the multicylinder engine is measured from the flange on the cylinder block.

order of 15 to 20 percent higher than it is when no inlet pipe is used. These optimum pipe lengths are slightly less than  $30 c/Nq$  where  $c$  is the velocity of sound in feet per second,  $N$  is the engine speed in revolutions per minute, and  $q$  is 3, 4, or 5.

3. For a single-cylinder engine, a fixed pipe length slightly less than  $6 c/N_m$  (where  $N_m$  is the highest operating speed) gives a higher mean effective pressure than no inlet pipe, for all operating speeds, although not as high as can be obtained with pipe length adjusted for each speed.

4. For a given engine speed and inlet pipe length, full advantage of the pressure waves in the pipe can be obtained only by suitable inlet valve timing, especially by proper choice of the time of inlet closing; longer pipes requiring later closing.

5. When three cylinders are connected to a single pipe, the best volumetric efficiency at high speed is obtained with the minimum length of pipe.

Massachusetts Institute of Technology,  
Cambridge, Mass., January 1938.

## REFERENCES

1. Koester, E. W.: Luftkompressoren. Z.V.D.I., Bd. 48, 1904, p. 109.
2. Borth, W.: Untersuchungen über den Verbrennungsvergang in der Gasmaschine, Z.V.D.I., Bd. 52, 1908, p. 520.
3. Voissel, P.: Resonanzerscheinungen in der Saugleitung von Compressoren und Gasmotoren. Z.V.D.I., Bd. 56, 1912, p. 720; VDI-Forschungsheft 106.
4. Gramberg, A.: Wirkungsweise und Berechnung der Windkessel von Kolbenpumpen. Z.V.D.I., Bd. 55, 1911, pp. 842 and 888; VDI-Forschungsheft 129.
5. Borth, W.: Schwingungs- und Resonanzerscheinungen in der Rohrleitungen von Kolbengebläsen, Z.V.D.I., Bd. 60, 1916, pp. 565, 591, and 611.
6. Matthews, Robertson, and Gardiner, Arthur W.: Increasing the Compression Pressure in an Engine by Using a Long Intake Pipe. NACA TN No. 180, 1924.
7. Capetti, Antonio: Effect of Intake Pipe on the Volumetric Efficiency of an Internal Combustion Engine. NACA TM No. 501, 1929.
8. Stier, Ernst: Spülung und Aufladung bei Zweitaktmotoren. Z.V.D.I., Bd. 73, Heft 39, Sept. 28, 1929, pp. 1389-1391.
9. Klusener, Otto: Saugrohr und Liefergrad. VDI-Sonderheft, Dieselmotoren, Heft 5, 1932, pp. 107-110.
10. List, Hans: Increasing the Volumetric Efficiency of Diesel Engines by Intake Pipes. NACA TM No. 700, 1933.
11. Dennison, E. S.: Inertia Supercharging of Engine Cylinders. Trans. A.S.M.E., vol. 55, no. 5, 1933, p. 53.
12. Lutz, O.: Resonanzschwingungen in den Rohrleitungen von Kolbenkraftmaschinen. Bericht aus dem Laboratorium der Verbrennungskraftmaschinen (Stuttgart), Heft 3, 1934.

13. Maier, W., and Lutz, O.: Resonanzerscheinungen in der Rohrleitung von Verbrennungskraftmaschinen. Bericht aus dem Laboratorium der Verbrennungskraftmaschinen (Stuttgart), Heft 3, 1934.
14. Mueller, R. K.: Inertia Supercharging: An Analysis of the Motion in the Intake Pipe of a Four Cycle Engine. M. S. Thesis, M.I.T., 1934.
15. Schmidt, T.: Schwingungen in Auspuffleitungen von Verbrennungsmotoren, Forschung auf dem Gebiete des Ingenieurwesens, Bd. 5, 1934, p. 226; VDI-Sonderheft, Dieselmotoren, Heft 6, 1936, pp. 79-89.
16. Lutz, O.: Grundsätzliche Betrachtungen über den Spülvorgang bei Zweitaktmaschinen, Forschung auf dem Gebiete des Ingenieurwesens, Bd. 5, 1934, p. 275; VDI-Sonderheft, Dieselmotoren, Heft 6, 1936, pp. 90-104.
17. Fischinger, A.: Bewegungsvorgänge in Gassäulen insbesondere beim Auspuff- und Spülvorgang von Zweitaktmaschinen, Forschung auf dem Gebiete des Ingenieurwesens, Bd. 6, Sept.-Oct., 1935, pp. 245-257 and Nov.-Dec., 1935, pp. 273-280; VDI-Sonderheft, Dieselmotoren, Heft 6, 1936, pp. 104-124.
18. Boden, E. H.: Dynamics of the Induction System of an Internal Combustion Engine. Ph. D. Thesis, M.I.T., 1936.
19. Shen, Y. C.: The Effect of Inlet Pipe Length on Volumetric Efficiency in a Multicylinder Engine. B. S. Thesis, M.I.T., 1937.
20. Ware, Marsden: Description of the N.A.C.A. Universal Test Engine and Some Test Results. NACA Rep. No. 250, 1927.
21. Taylor, E. S., and Draper, C. S.: A New High-Speed Engine Indicator. Mech. Eng., vol. 55, no. 3, March 1933, pp. 169-171.

## BIBLIOGRAPHY

- Eckhardt, E. A., and Others: Transmission of Sound through Voice Tubes. Bur. of Standards Tech. Paper 333, vol. 21, pp. 163-193.
- Lehmann, K. O.: Die Dampfungsverluste bei starken Schall-schwingungen in Rohren. Ann. der Phys., Bd. 21, 1934, p. 533.
- Schmidt, E.: Schwingungen grosser Amplitude von Gassäulen in Rohrleitungen. Z.V.D.I., Bd. 79, 1935, p. 671; VDI-Sonderheft, Dieselmotoren, Heft 6, 1936, p. 125.
- Morse, Philip M., Boden, R. H., and Schechter, Harry: Acoustic Vibrations and Internal Combustion Engine Performance. Jour. of Appl. Phys., vol. 9, no. 1, Jan. 1938, pp. 16-23.
- Rayleigh, John William Strutt: The Theory of Sound. Vol. 2. MacMillan and Co. (London), 2d ed., 1896.
- Grandall, Irving B.: Theory of Vibrating Systems and Sound. D. Van Nostrand Co., 1926.
- Morse, Philip M.: Vibration and Sound. McGraw-Hill Book Co., Inc. 1st ed., 1936.

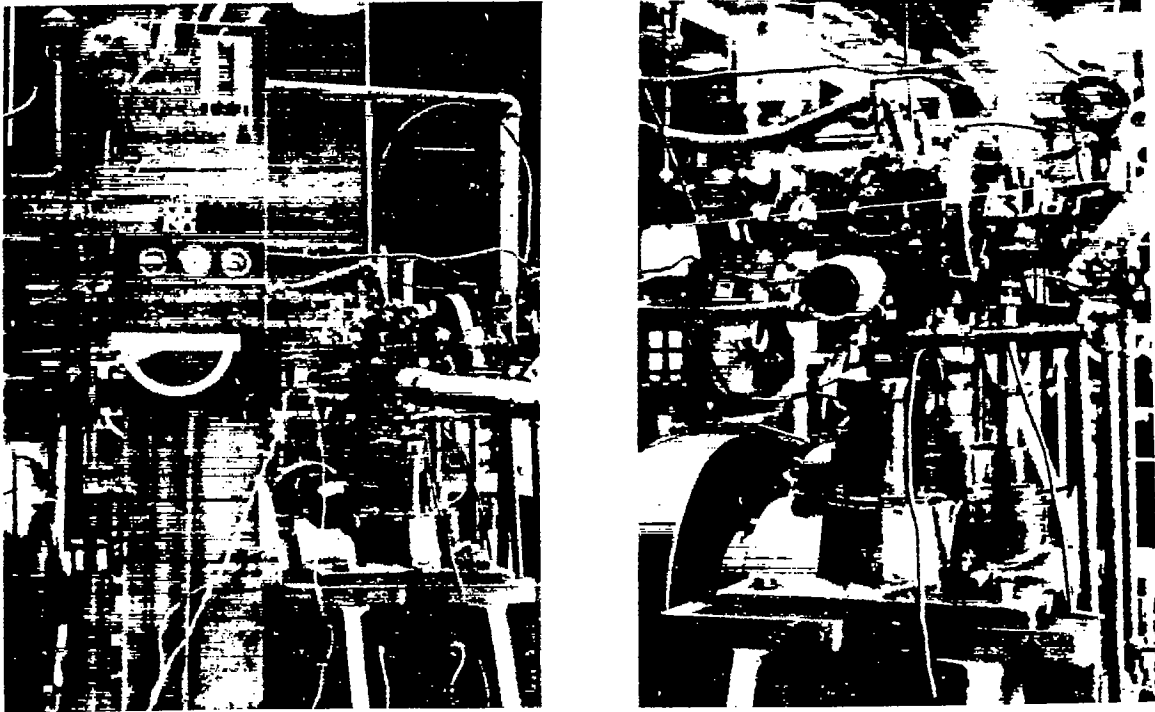
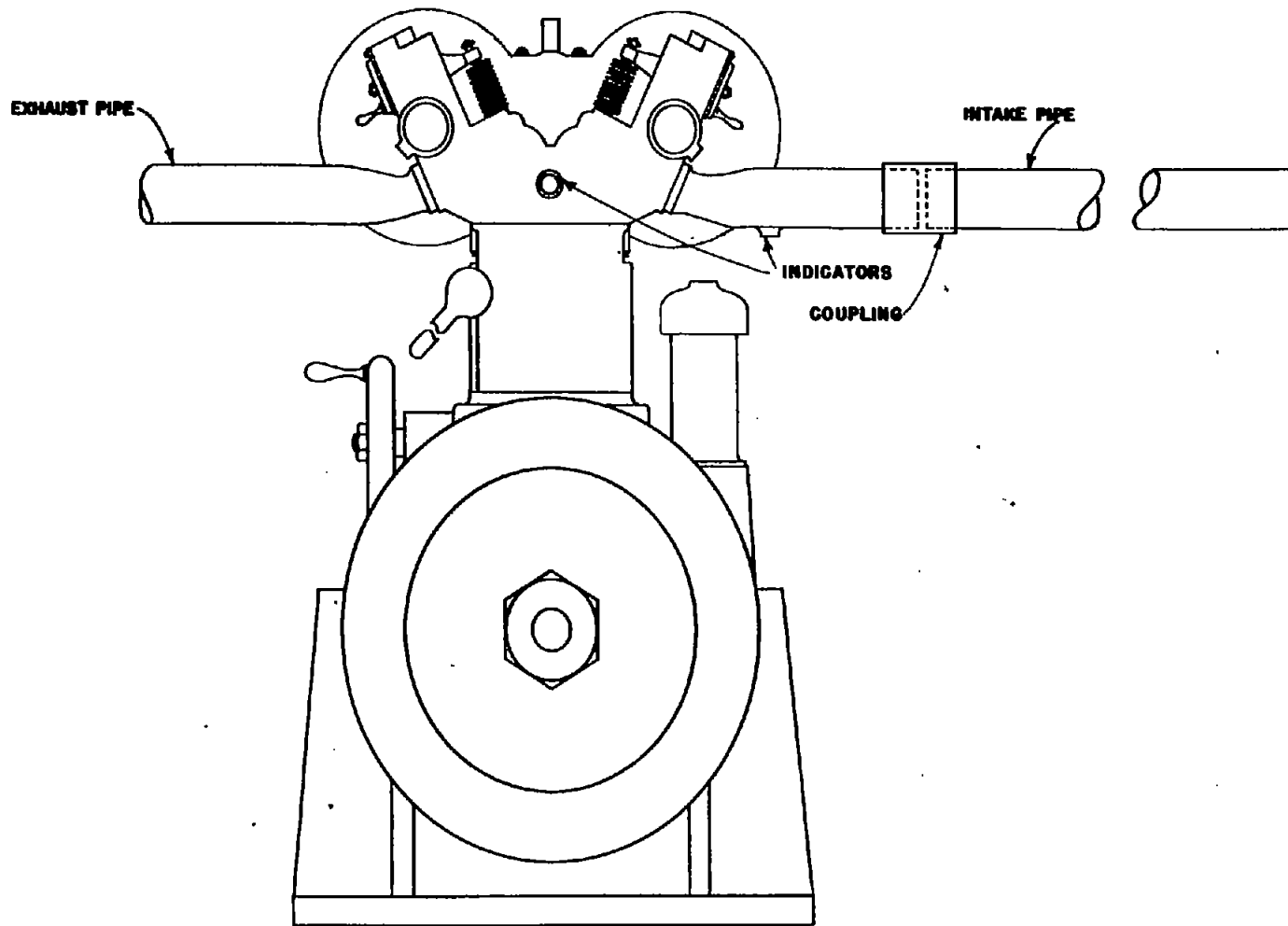
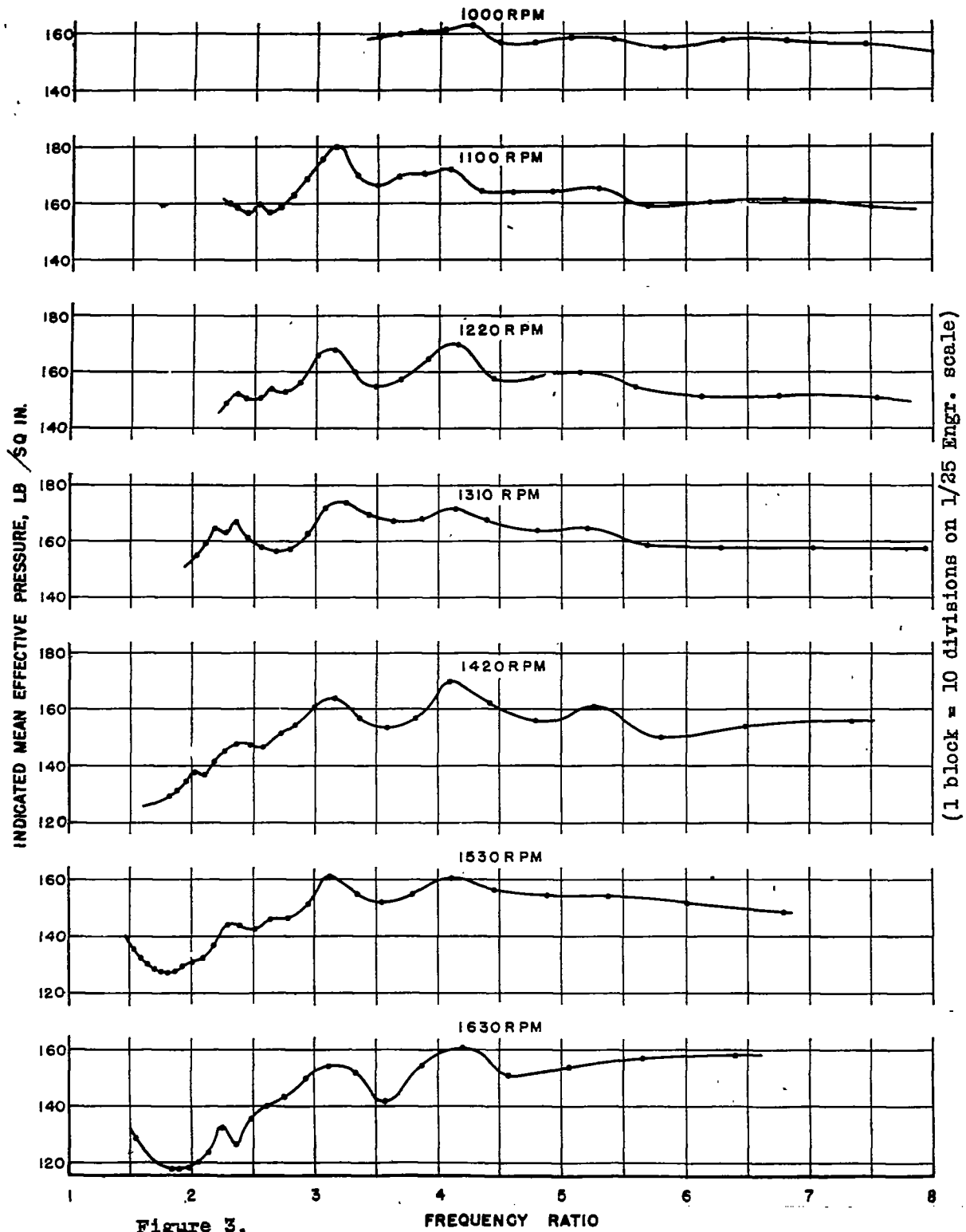

Figure 1. Experimental setup.



**NACA UNIVERSAL TEST ENGINE**  
Figure 2.





(1 block = 10/25°)

Fig. 4

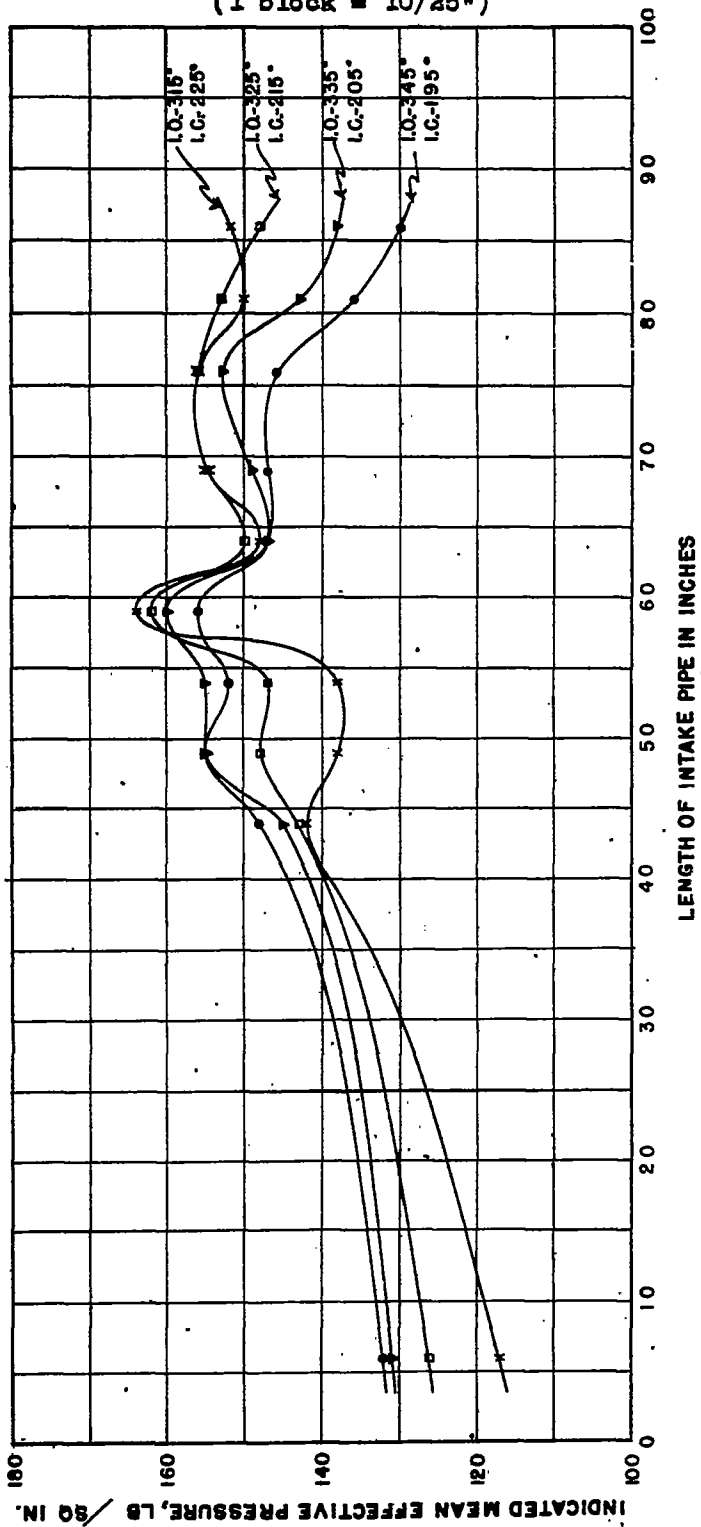

LENGTH OF INTAKE PIPE IN INCHES  
Figure 4.

(1 block = 10/25\*)

Fig. 5

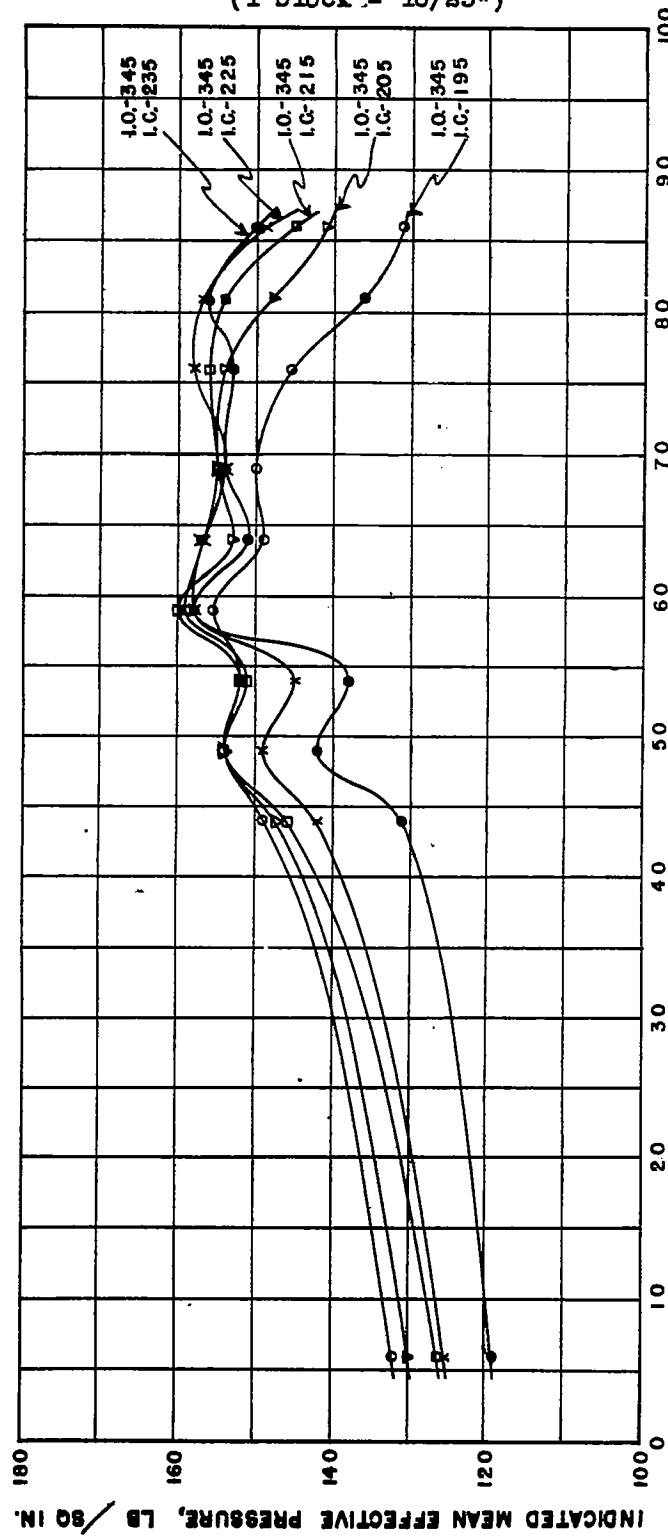

LENGTH OF INTAKE PIPE IN INCHES  
Figure 5.

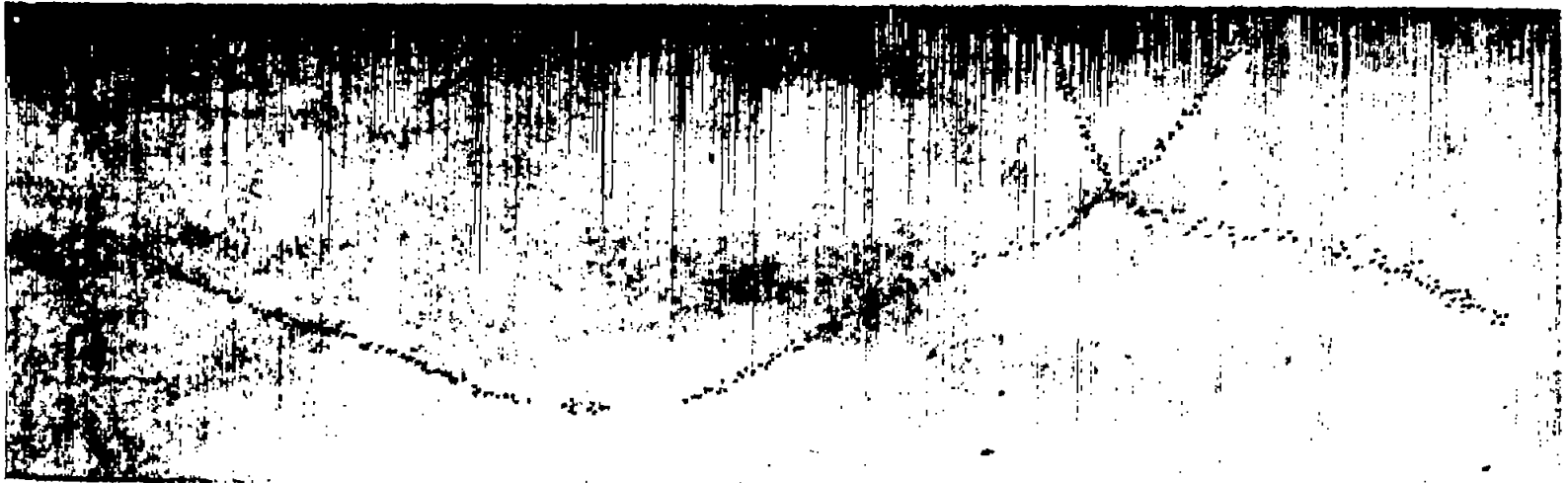

T.C.      7/20/36      1610 RPM      86" pipe      I.O. 335°      I.C. 205°

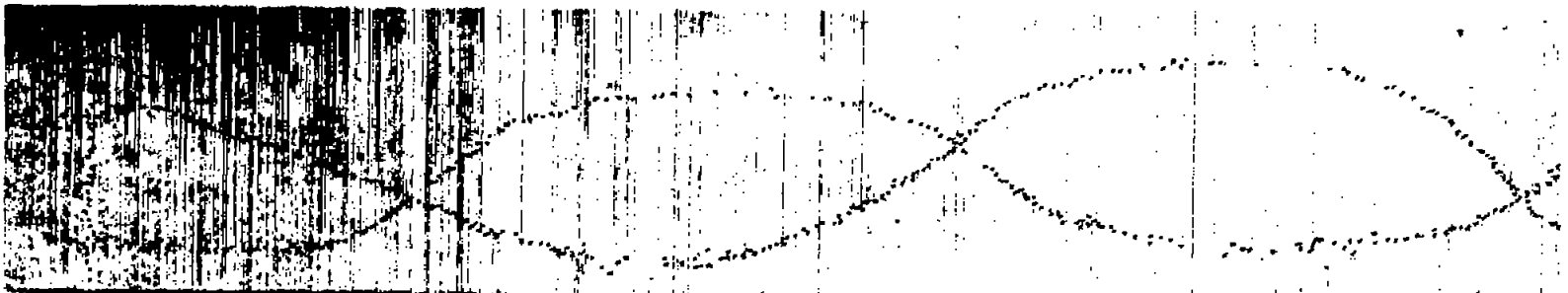

T.C.      7/20/36      1610 RPM      86" pipe      I.O. 335°      I.C. 205°

Figure 6.- Typical indicator cards.

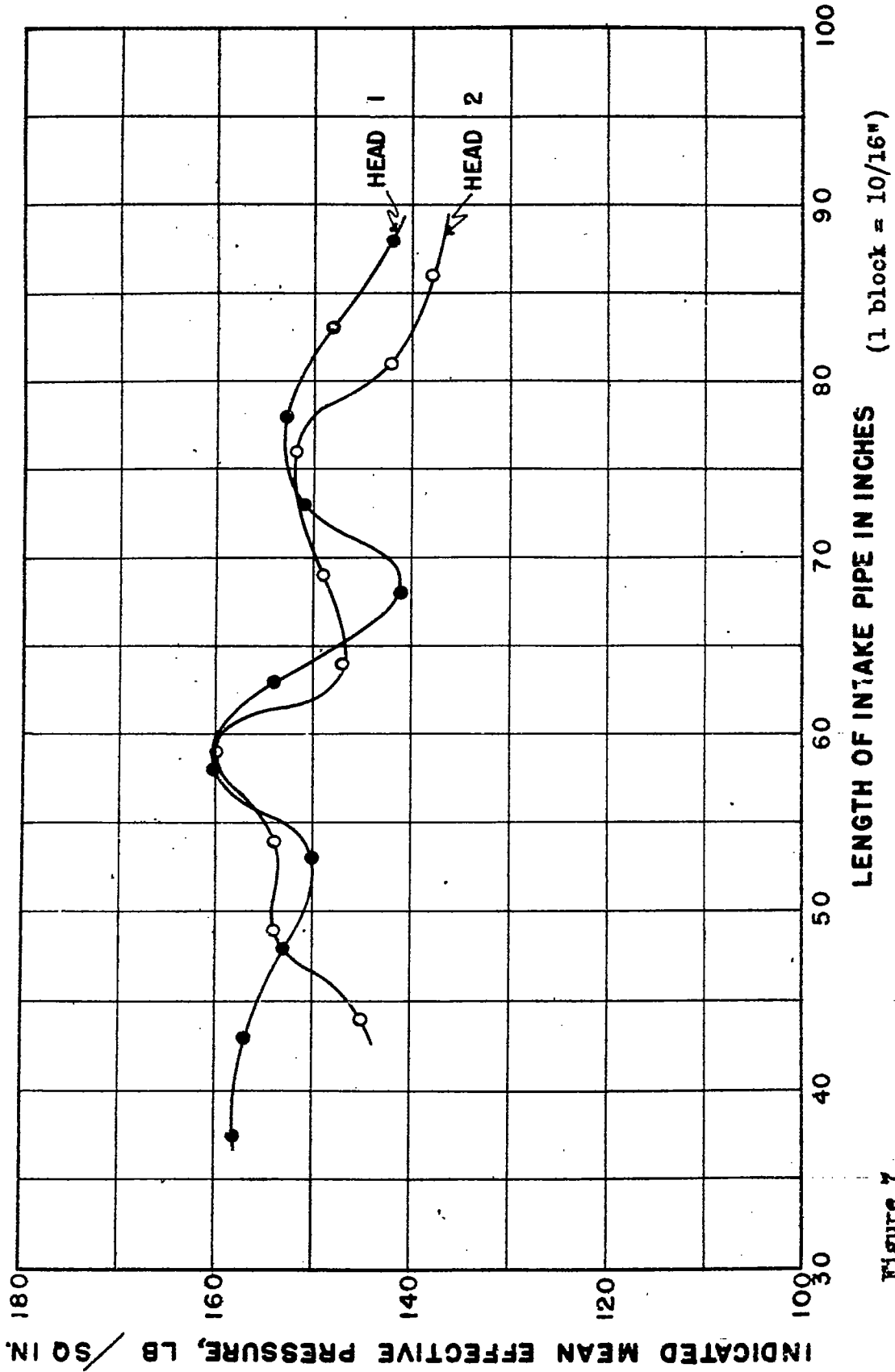

Figure 7

(1 block = 10/16")

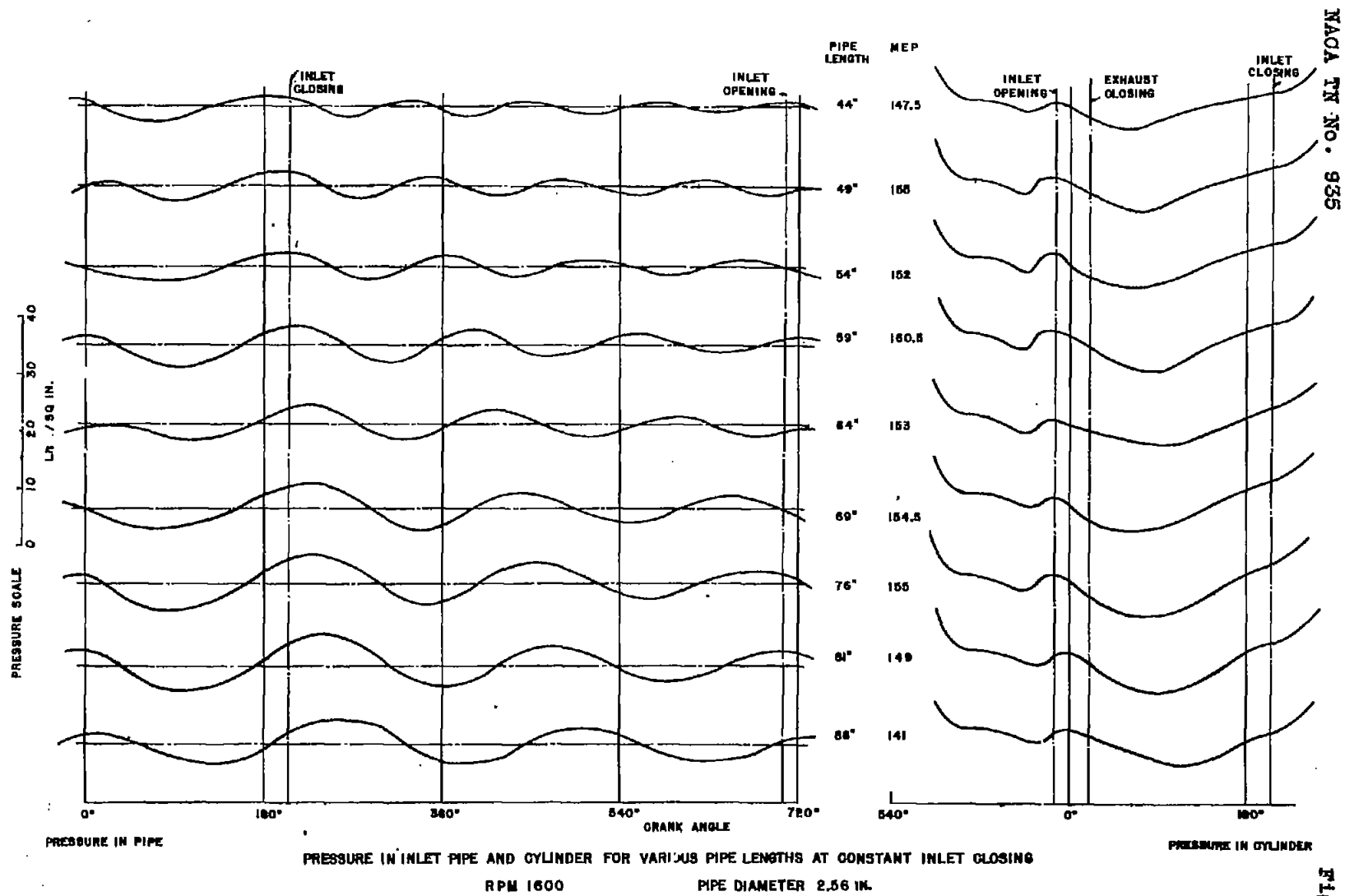
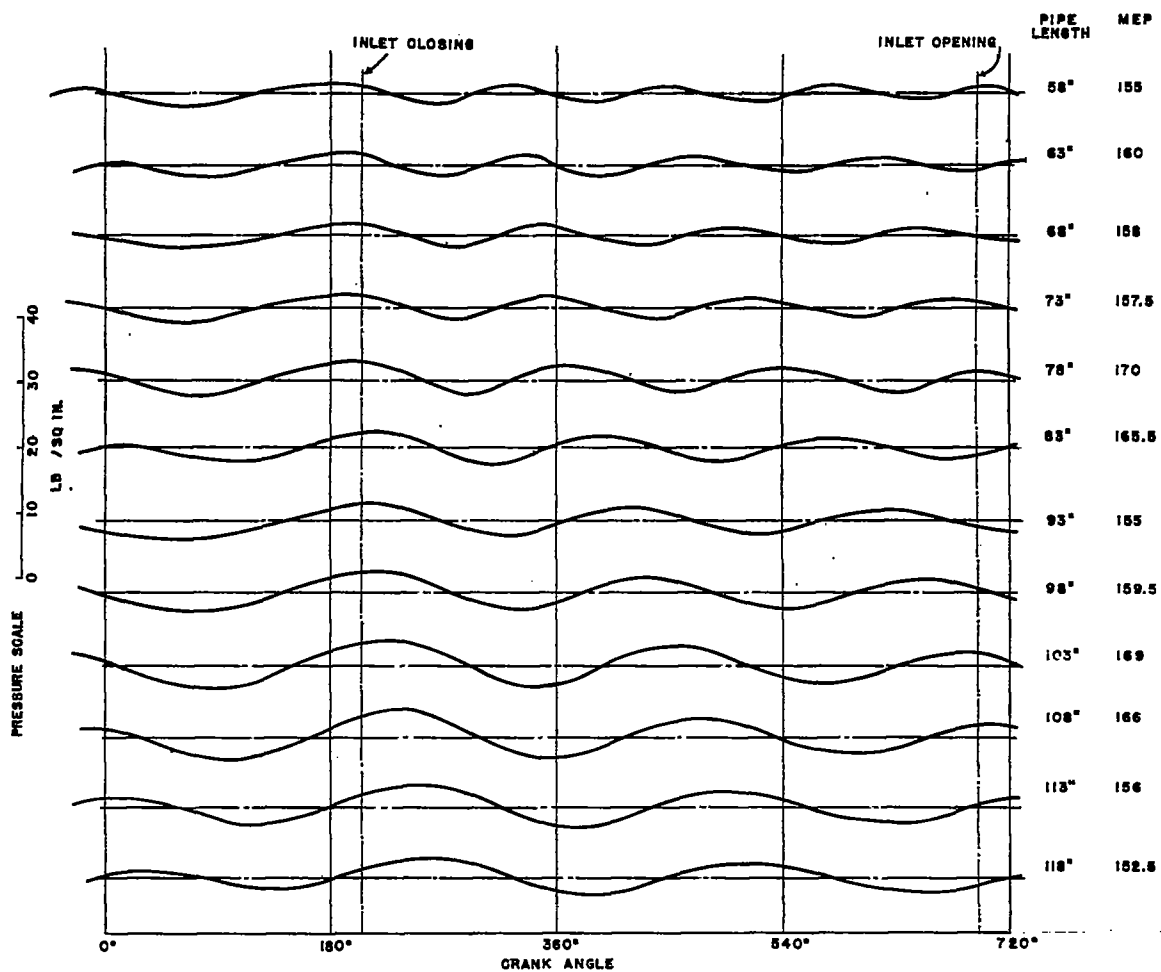
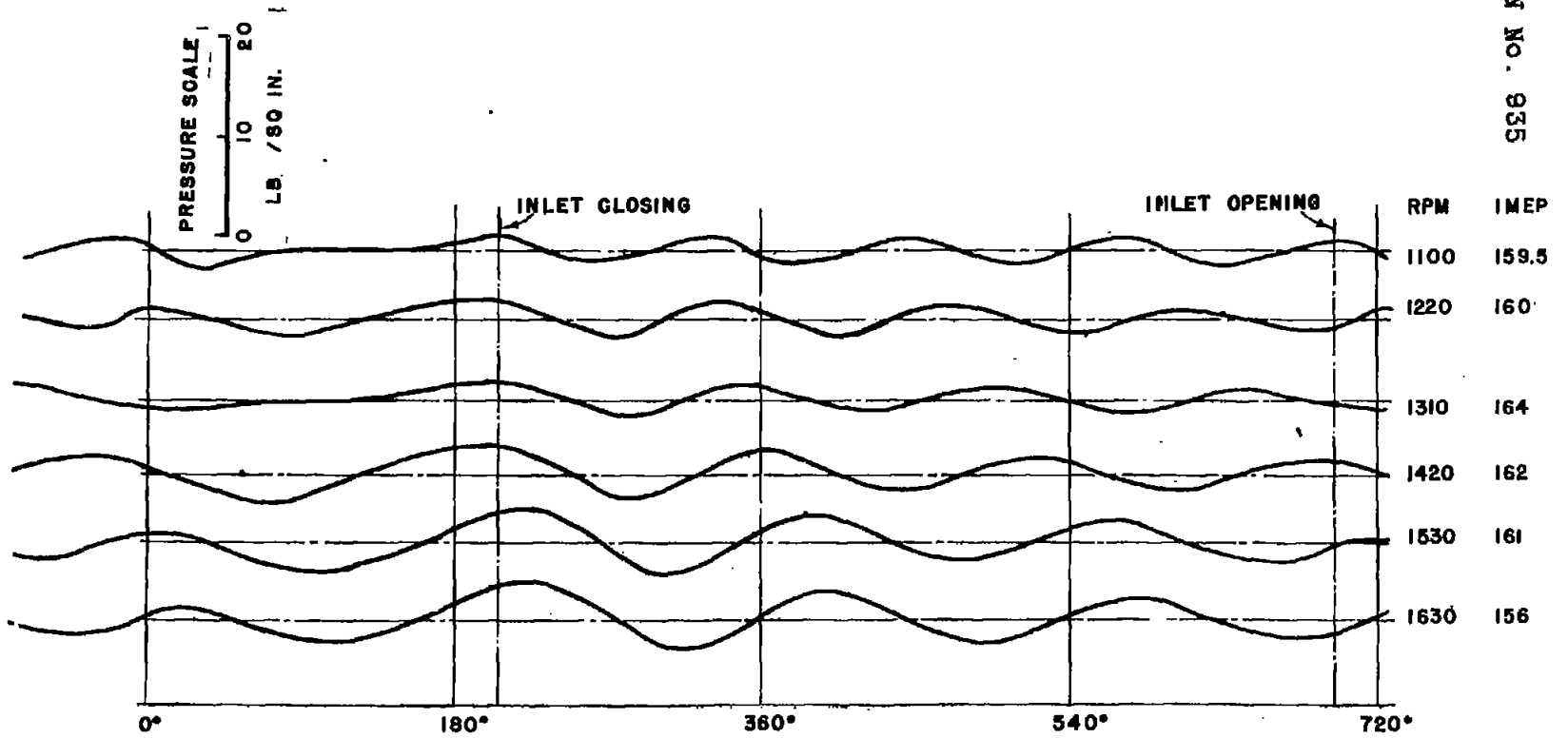

Fig. 8.



PRESSURE IN INLET PIPE FOR VARIOUS PIPE LENGTHS AT CONSTANT INLET CLOSING  
 RPM 1220 PIPE DIAMETER 2.56 IN.

Figure 9.



PRESSURE IN PIPE AT DIFFERENT RPM  
 PIPE LENGTH 63 IN.      DIAMETER 2.56 IN.

Figure 10

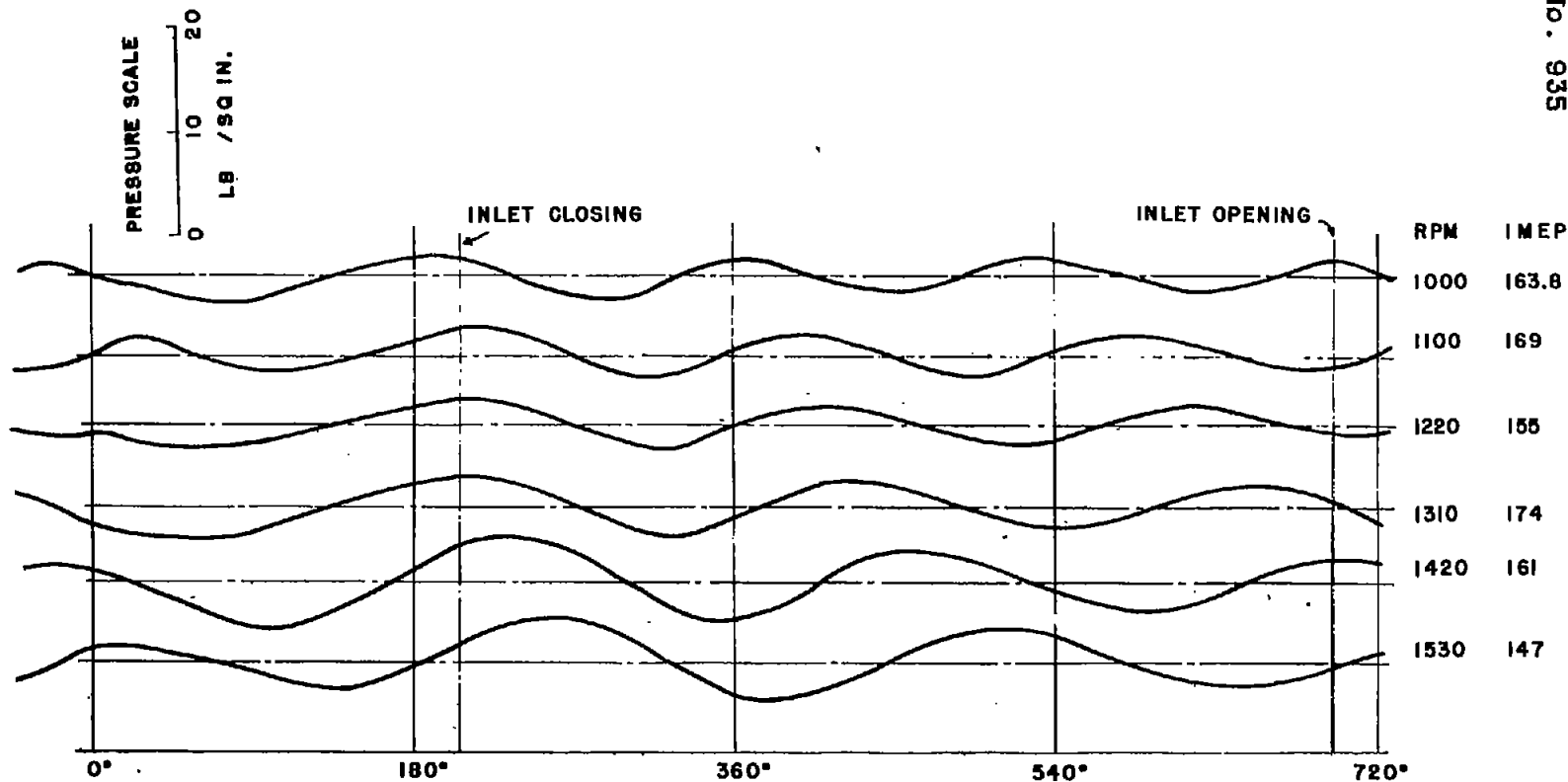

PRESSURE IN PIPE AT DIFFERENT RPM  
PIPE LENGTH 93 IN. DIAMETER 2.56 IN.

Figure 11



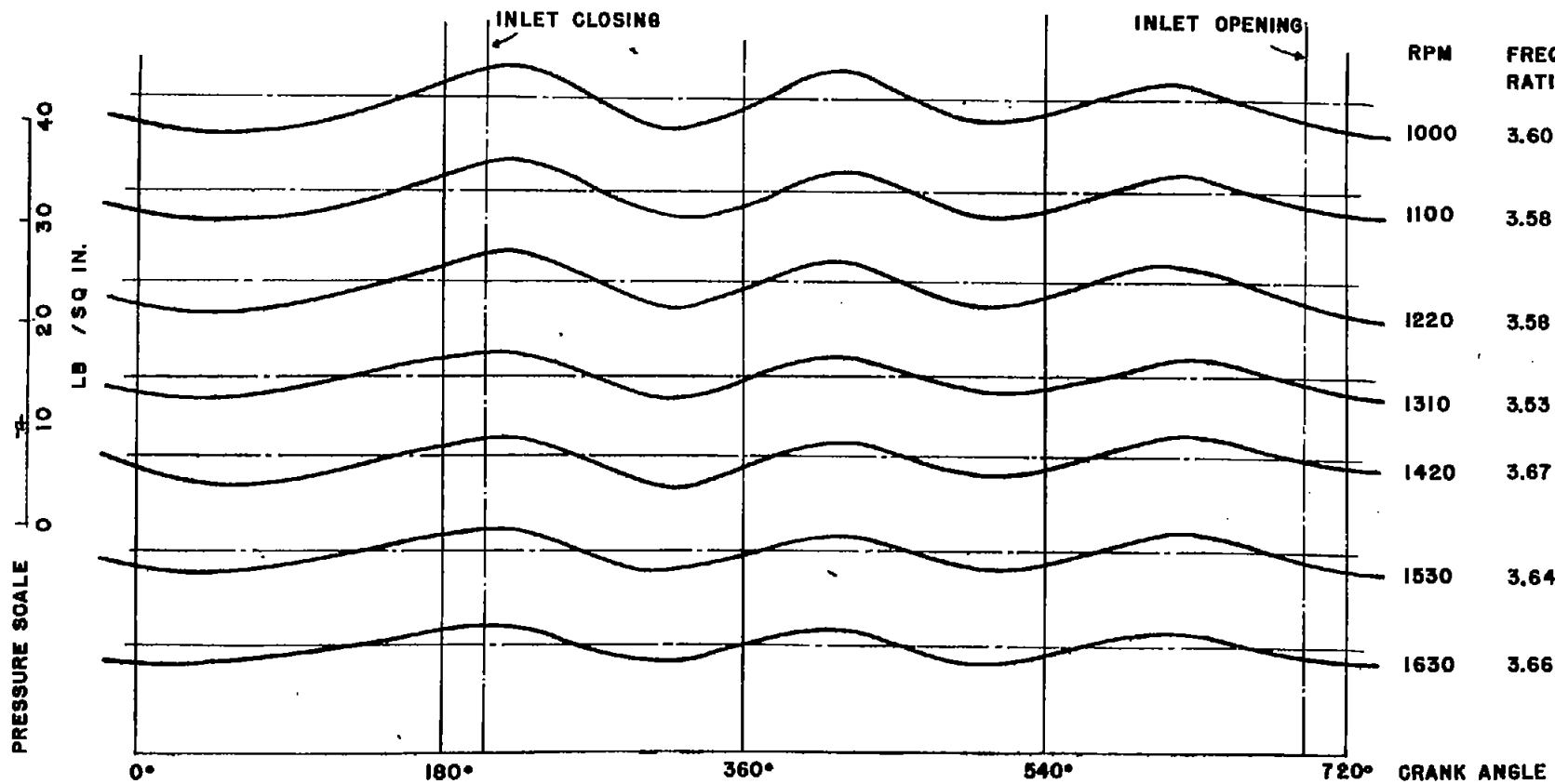

PRESSURE IN INLET PIPE FOR VARIOUS SPEEDS AT CONSTANT FREQUENCY RATIO

Figure 12

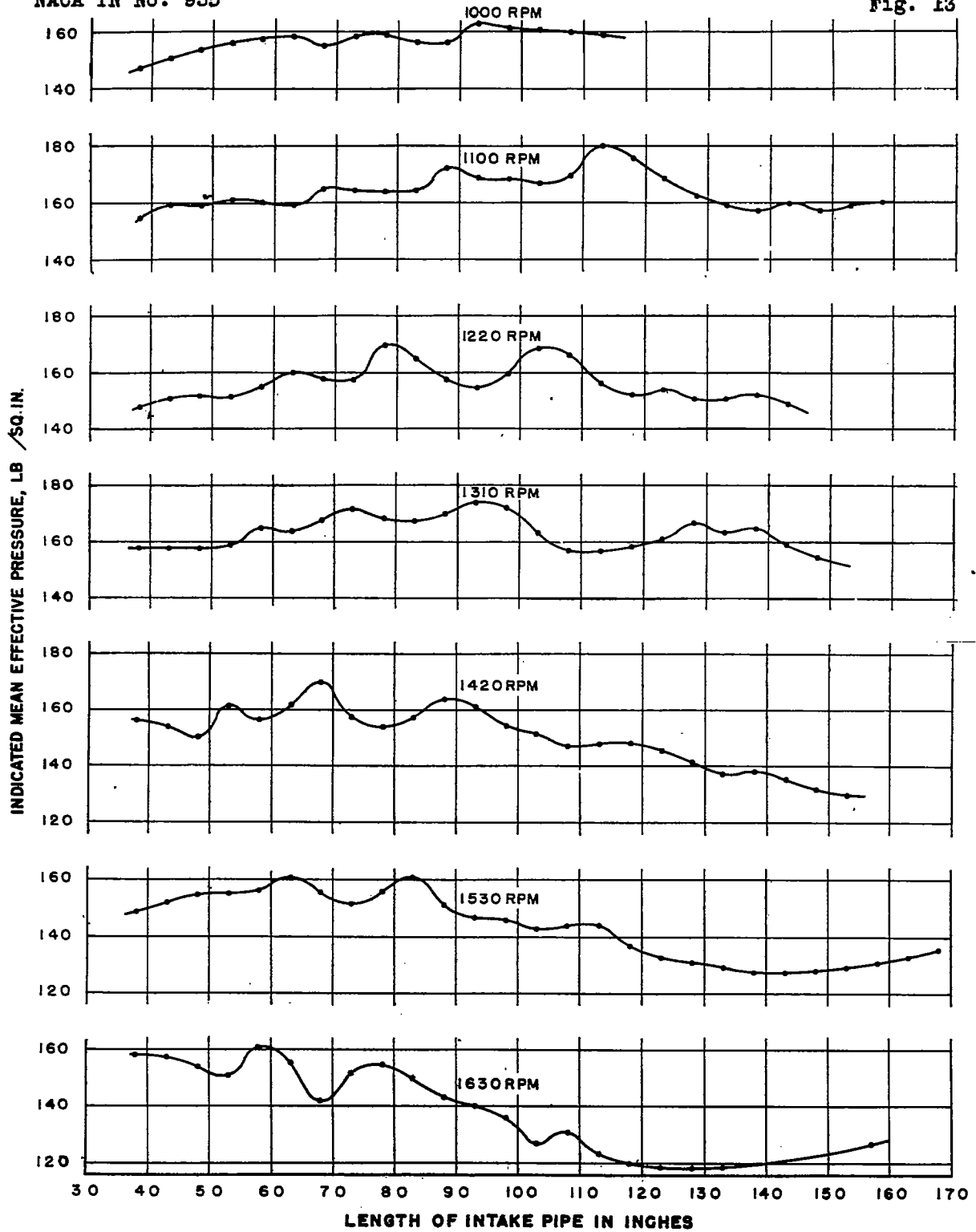
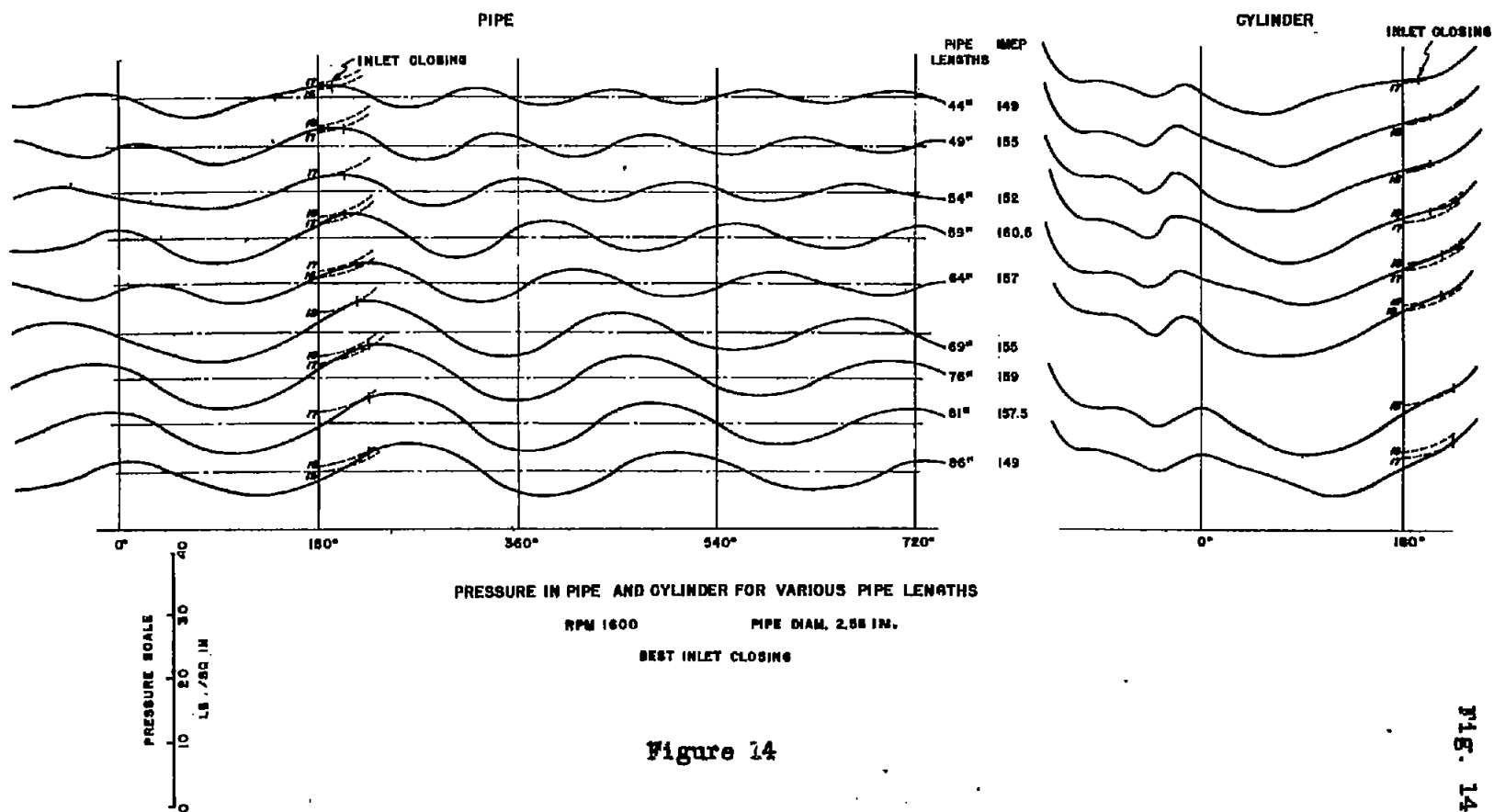

Figure 13



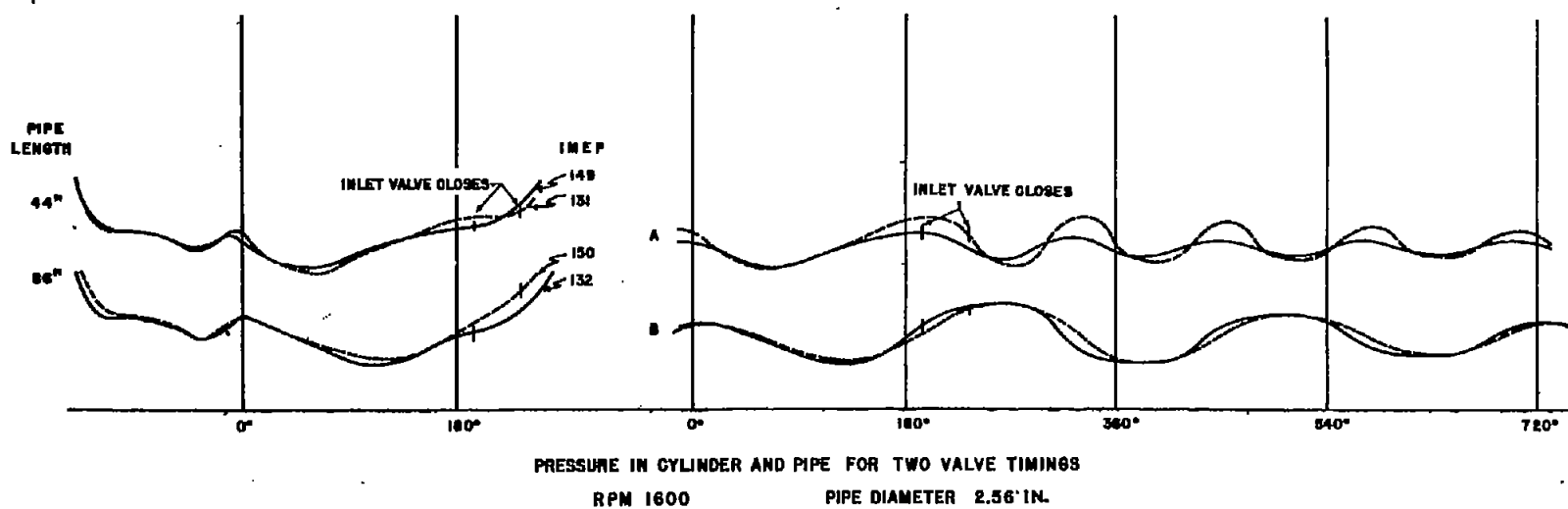

Figure 15

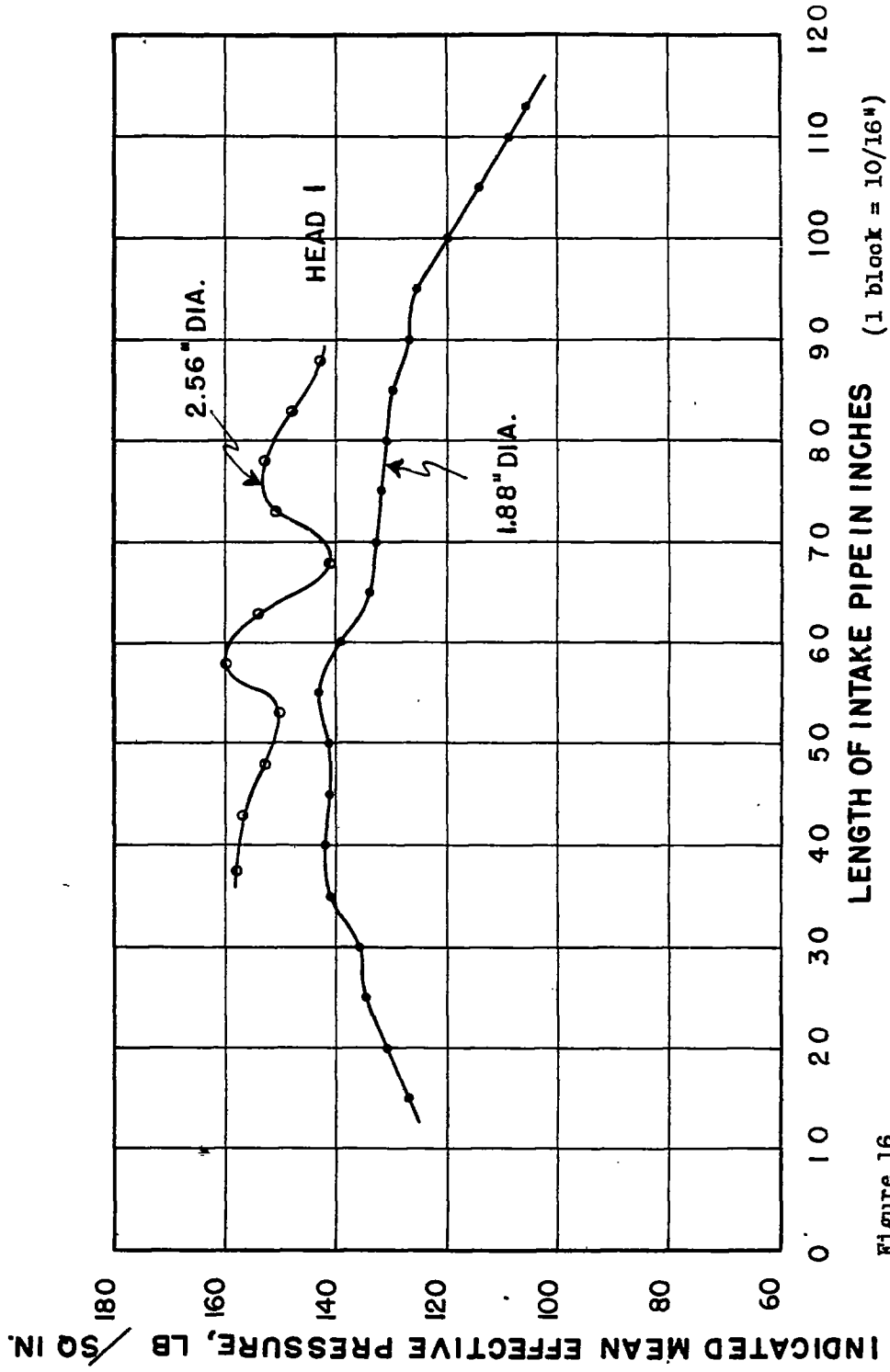

Figure 16

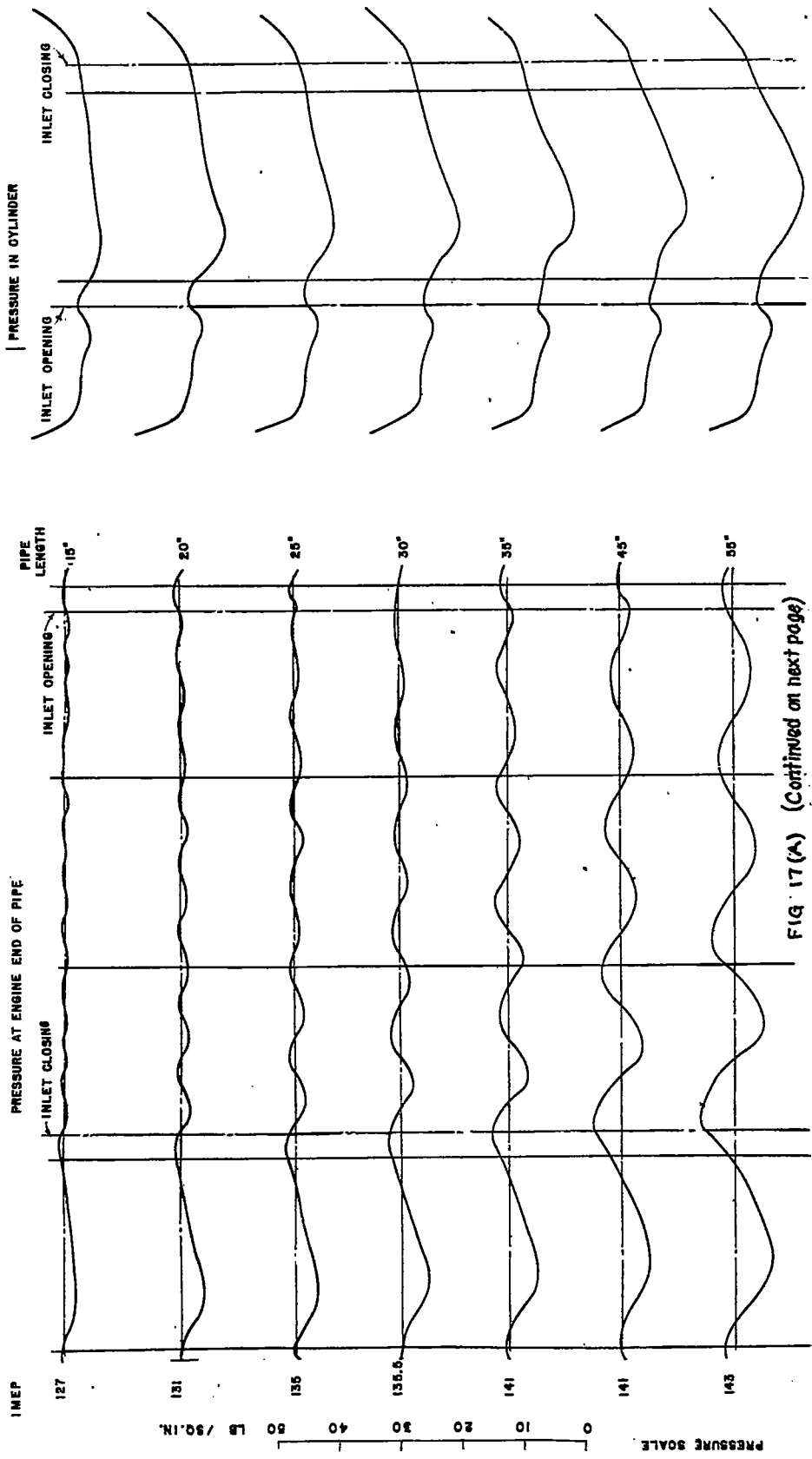

FIG. 17(A) (Continued on next page)

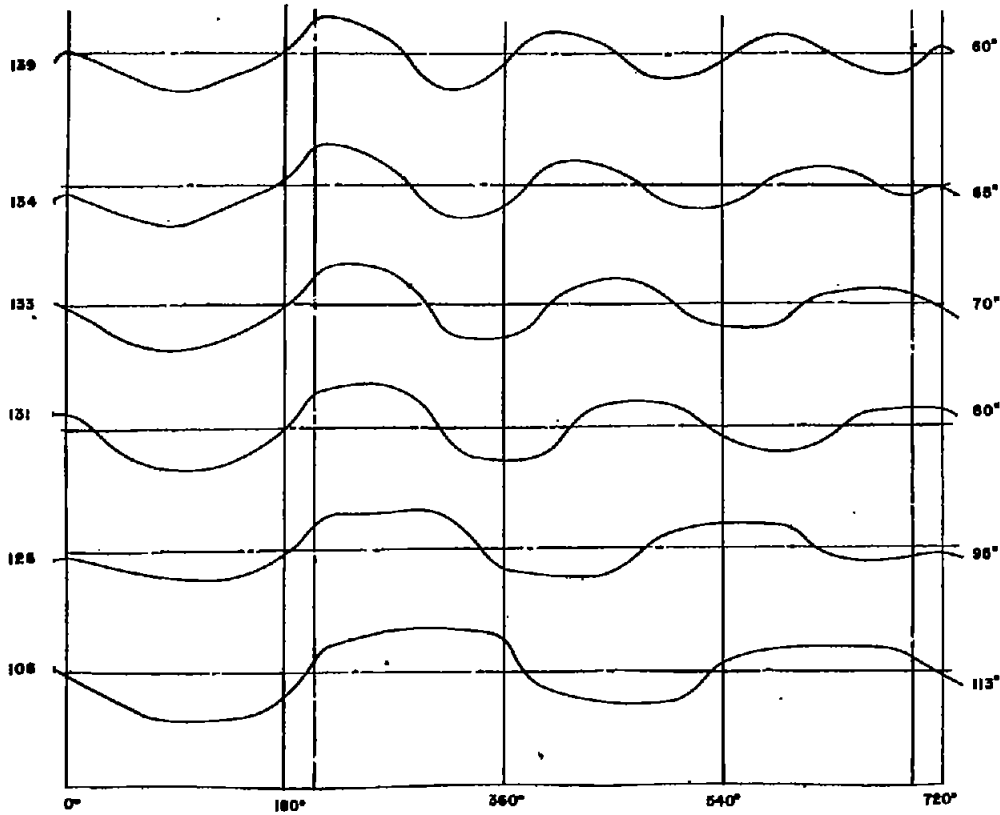

FIG. 17(B)

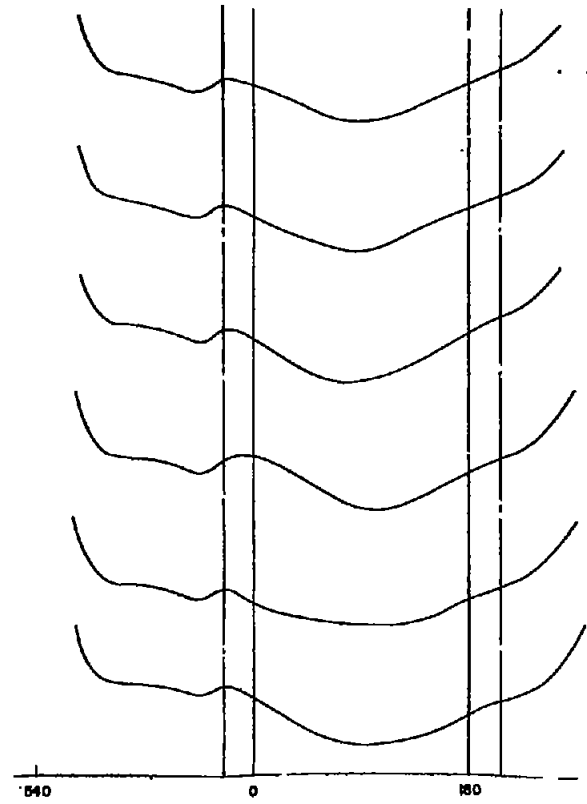
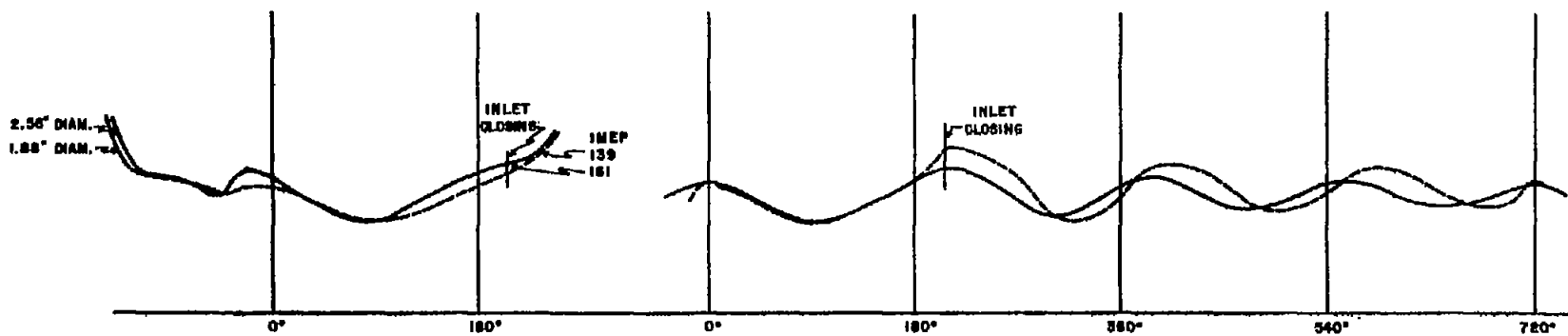

FIGURE 17. - PRESSURE IN PIPE AND CYLINDER FOR VARIOUS PIPE LENGTHS  
RPM 1600 PIPE DIAMETER 1.88" IN.



PRESSURE WAVES IN PIPE AND CYLINDER FOR 2.56" AND 1.88" DIAMETER PIPE  
 RPM 1600 PIPE LENGTH 59 IN.

Figure 18.



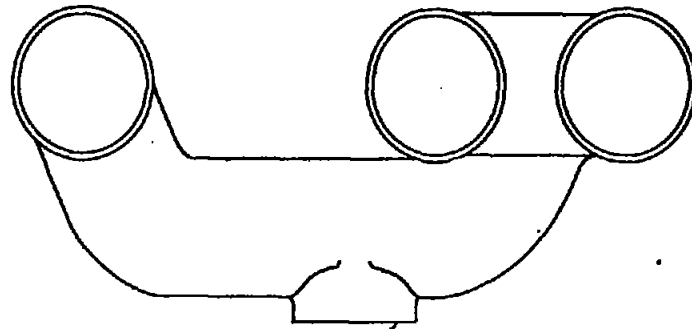

INLET PIPE ATTACHES HERE

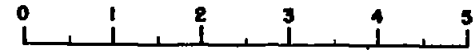

SCALE — INCHES

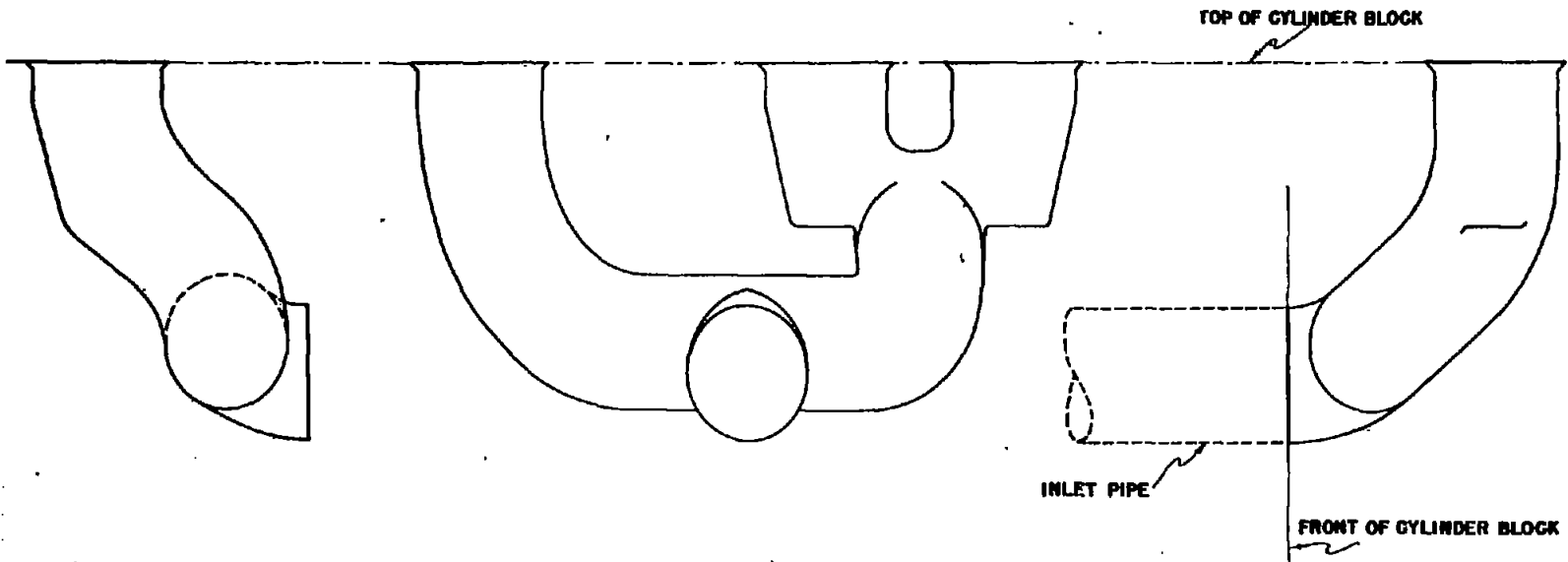

TOP OF CYLINDER BLOCK

INLET PIPE

FRONT OF CYLINDER BLOCK

Figure 19.

DETAIL OF INLET PASSAGE CORE  
MODIFIED TO SHOW SHAPE OF PASSAGE AFTER MACHINING

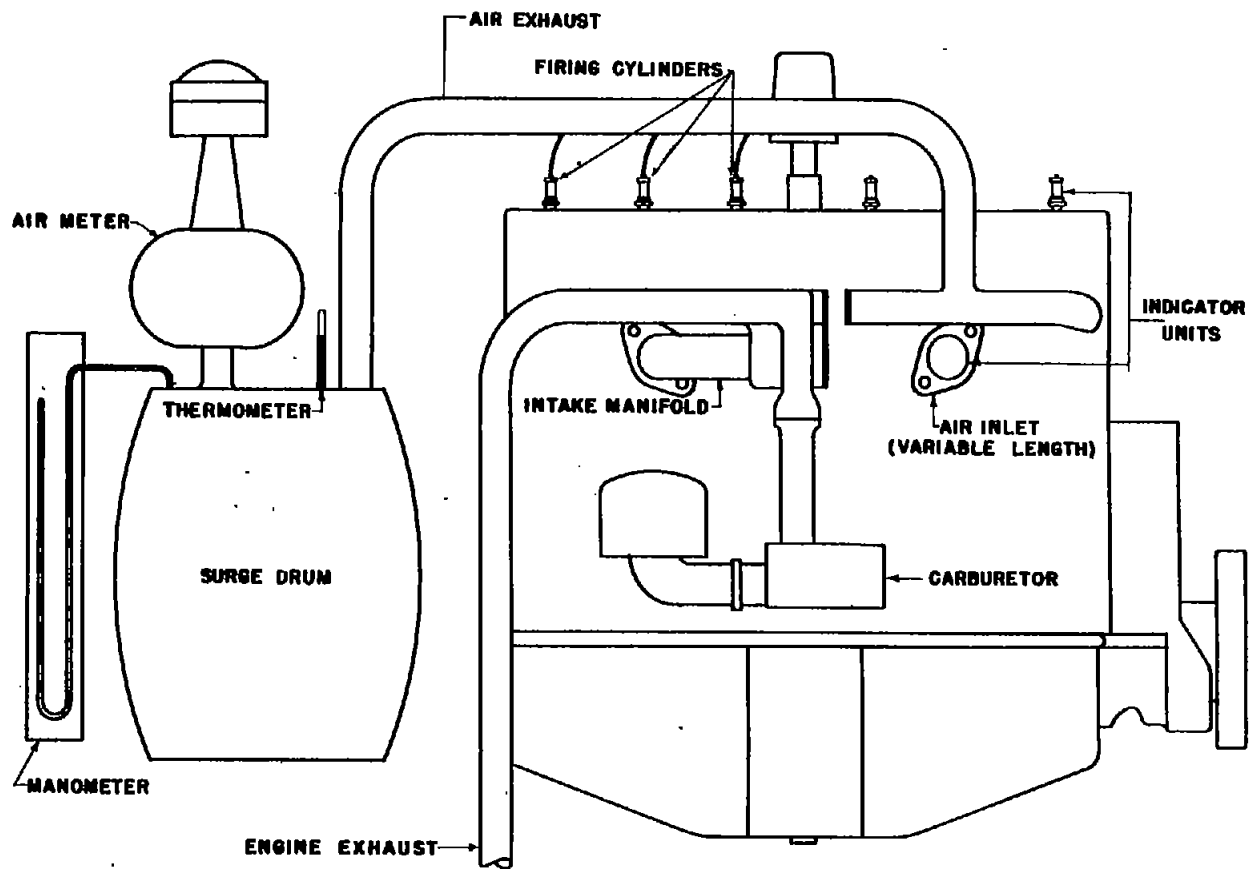
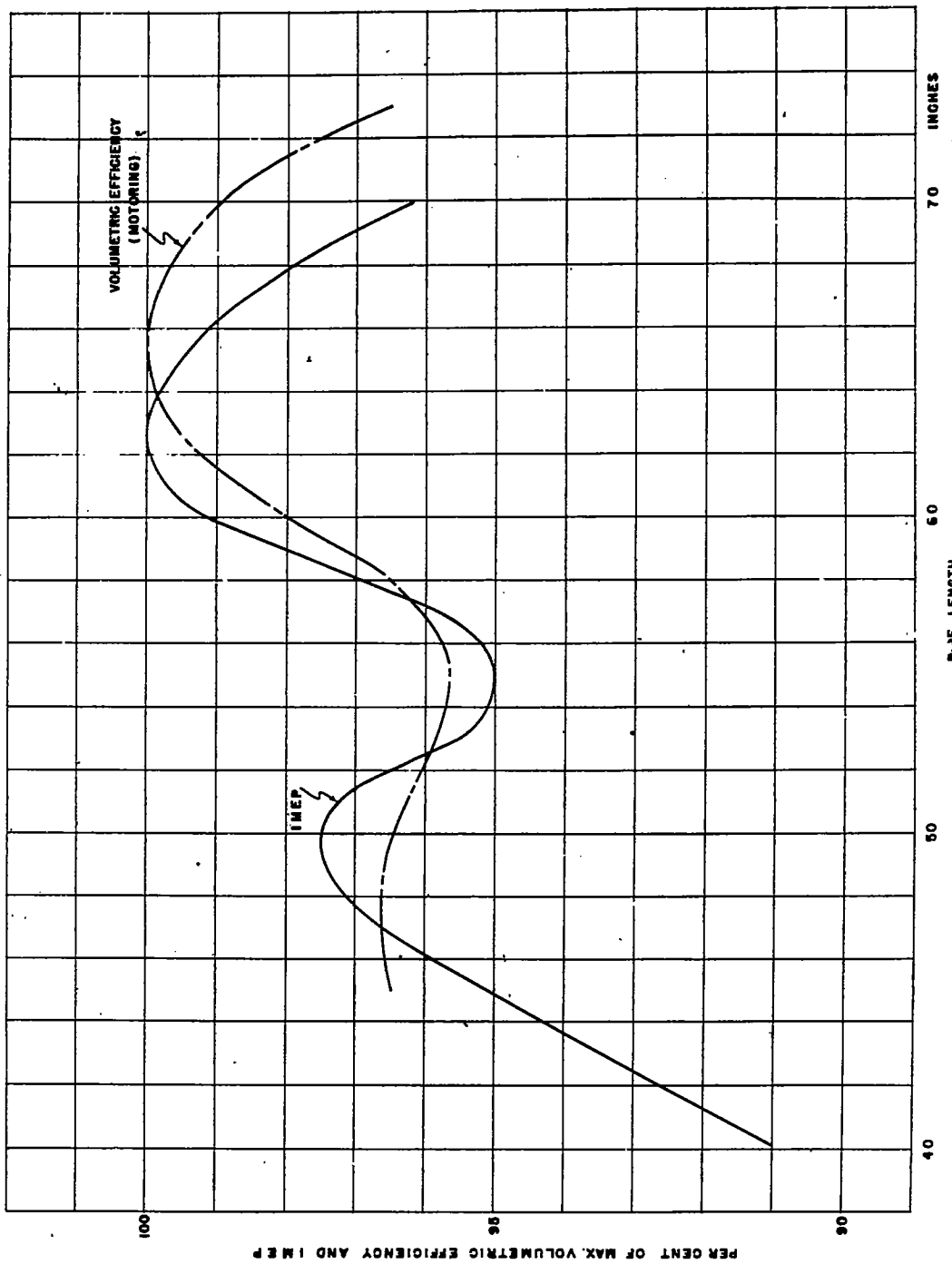

Figure 20.



(1 block = 10/25")

Figure 21

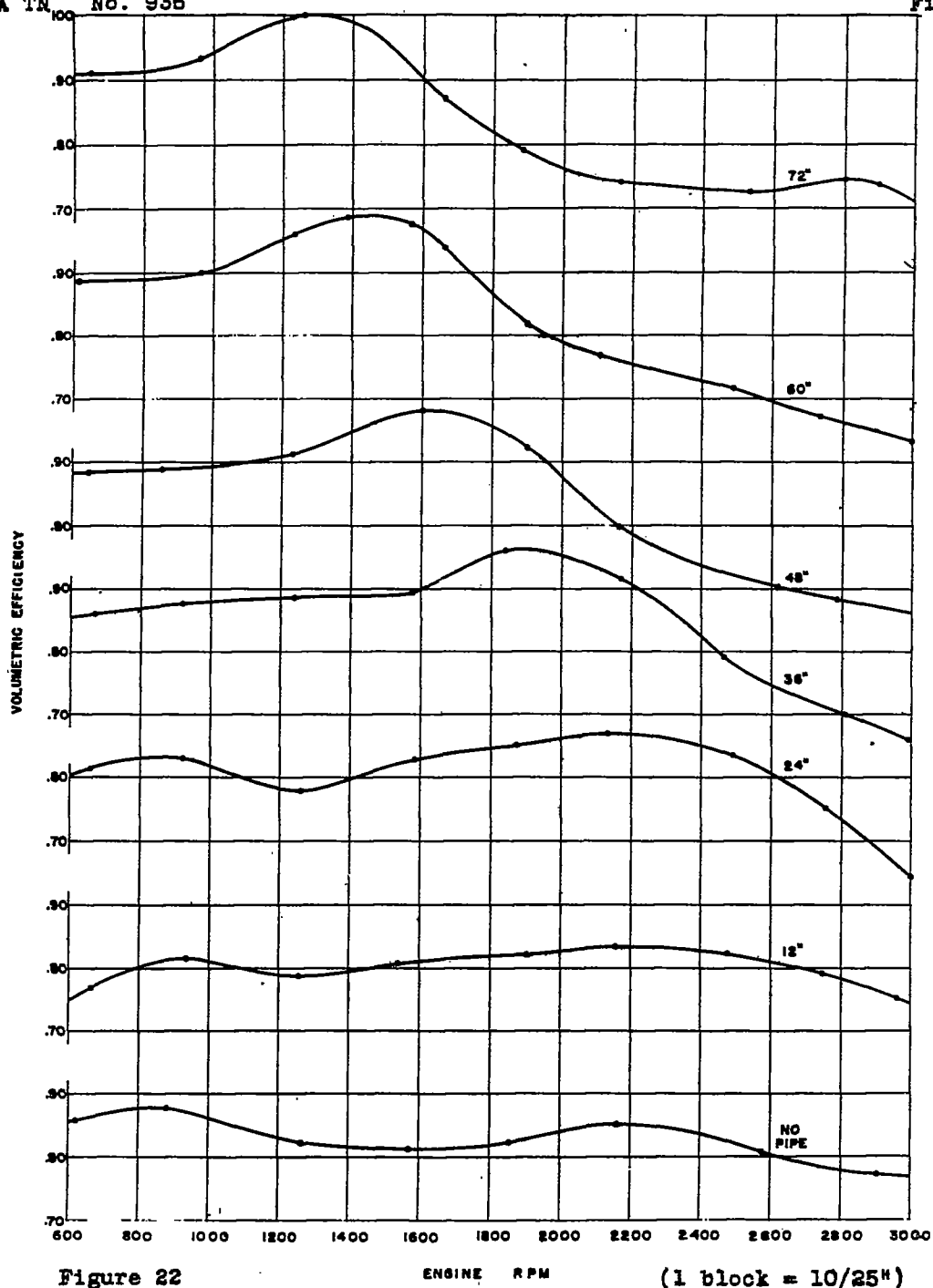

Figure 22

ENGINE RPM

(1 block = 10/25")

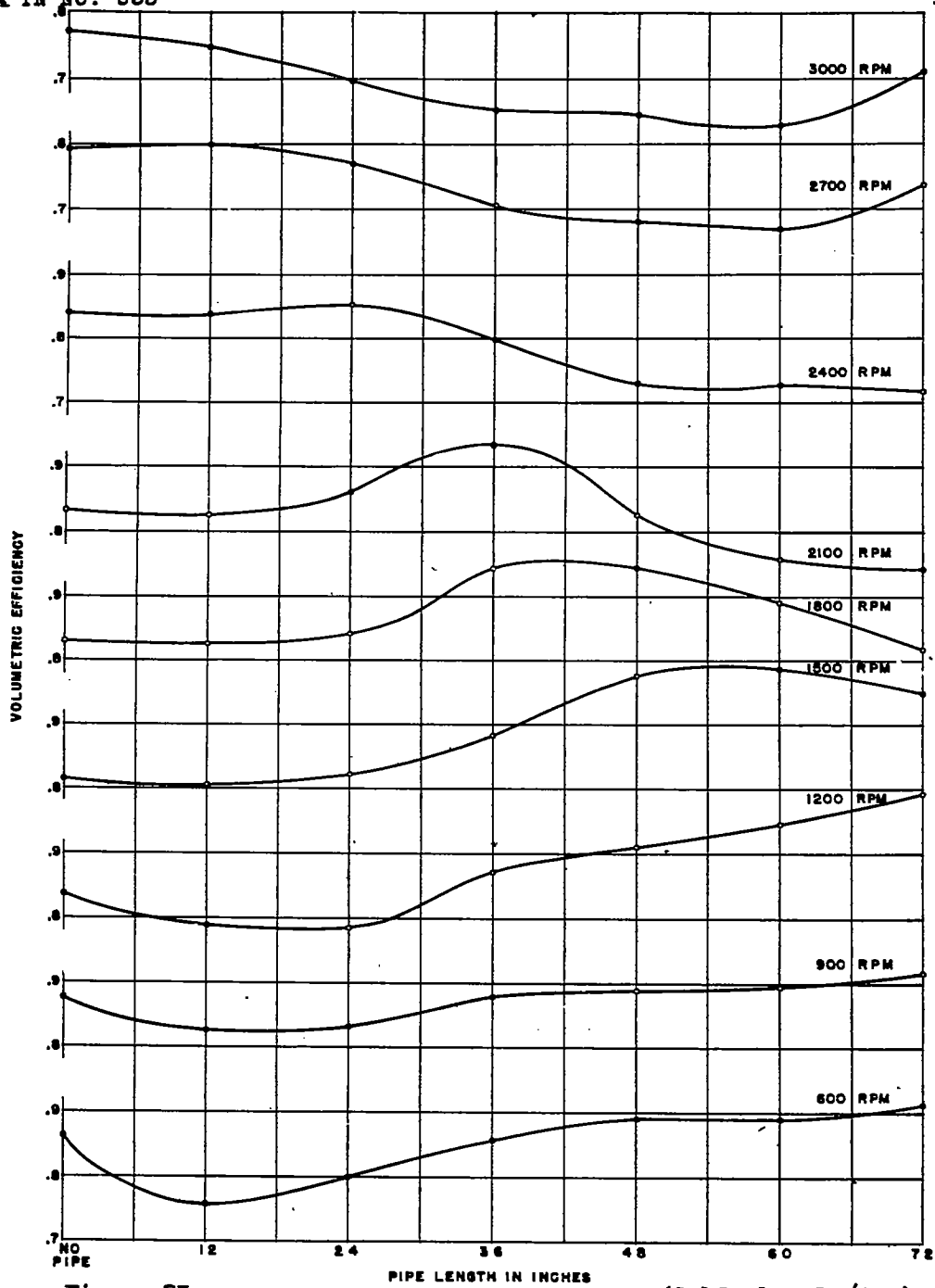
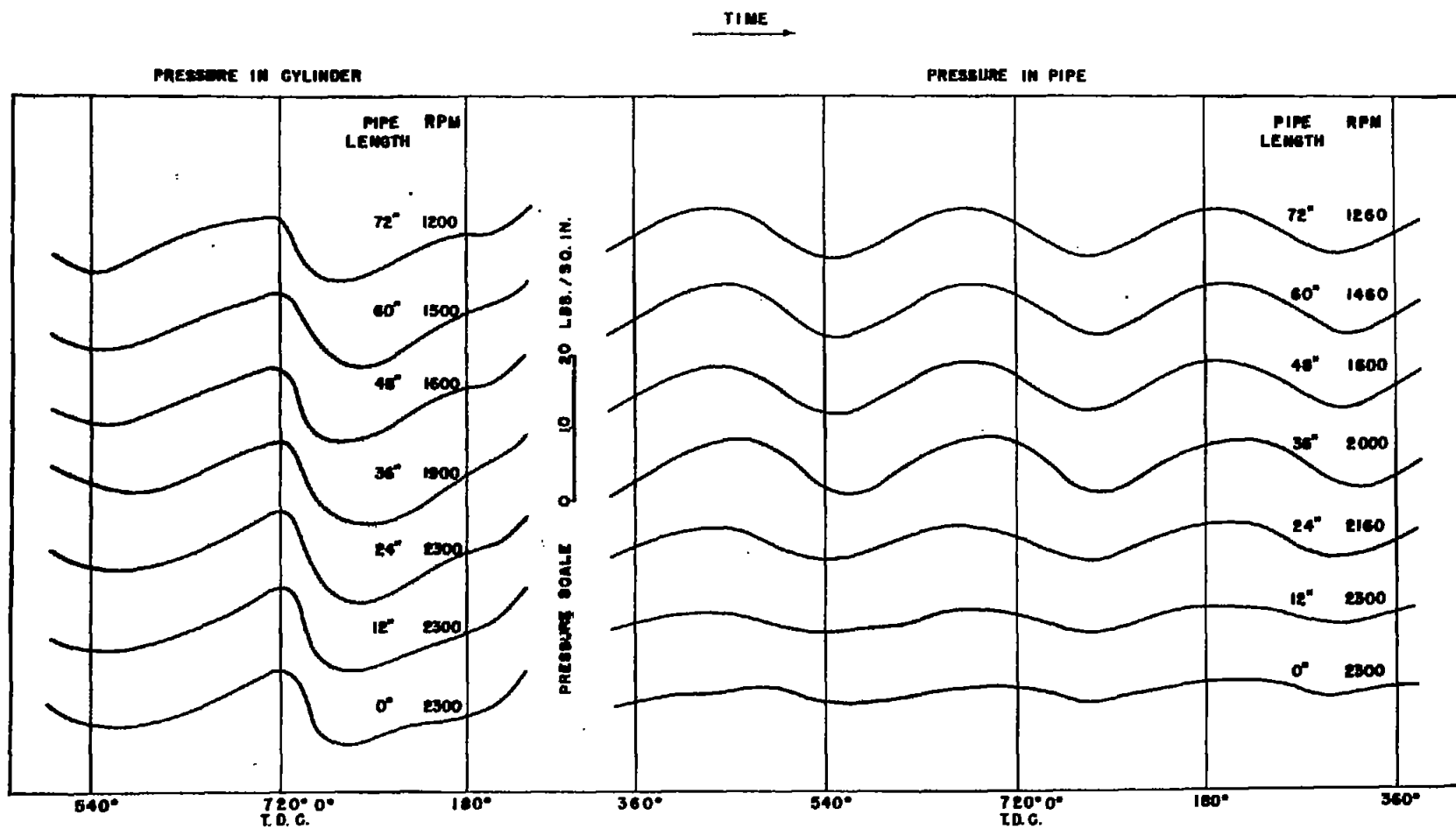

Figure 23

(1 block = 10/25<sup>n</sup>)



PRESSURE CURVES FOR BEST VOLUMETRIC EFFICIENCY

(THREE CYLINDERS)

Figure 24.

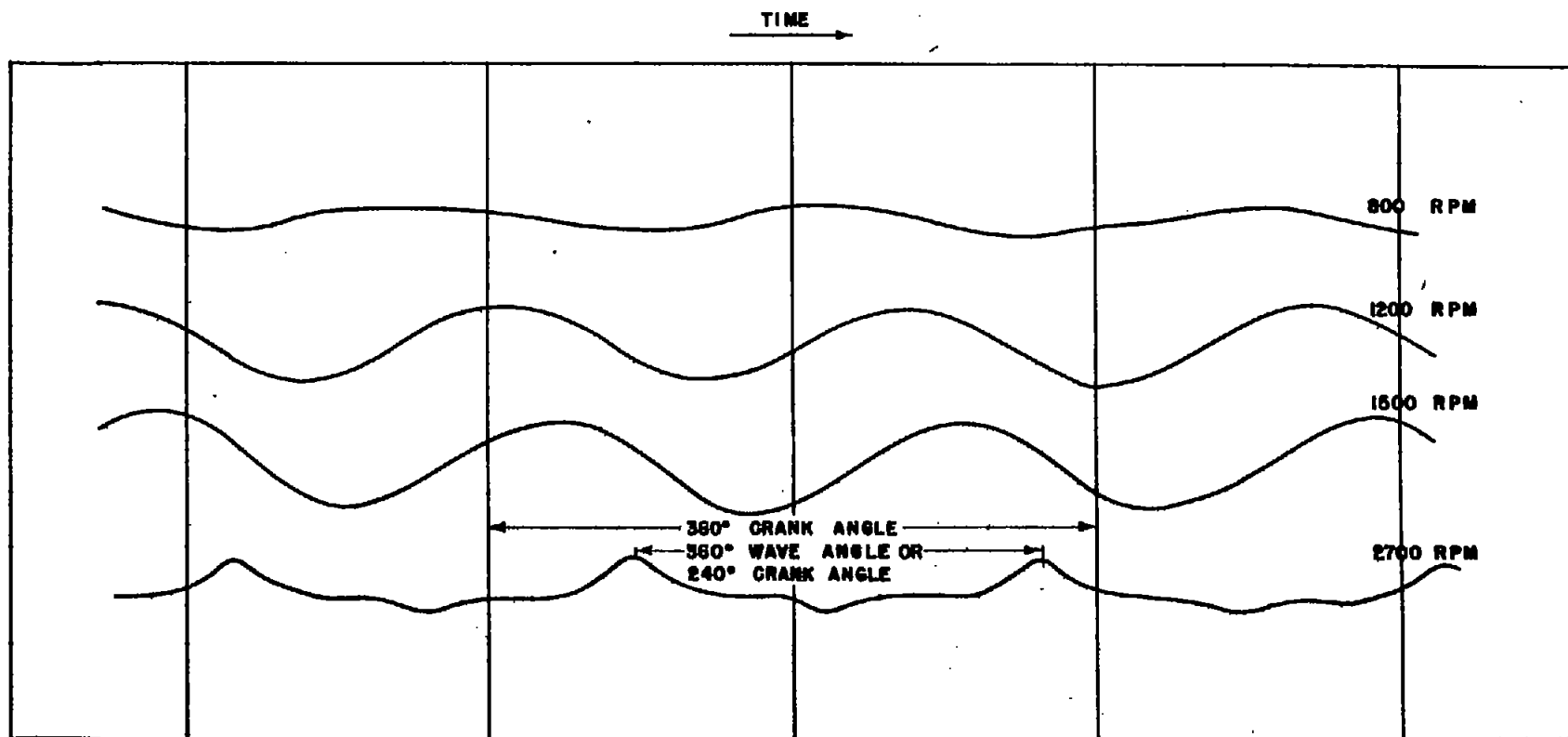

PRESSURE CURVES AT VARIOUS R P M  
72 INCH PIPE

( THREE CYLINDERS )  
Figure 25.